

X3-FORTH

Installation Manual

X3-FTH-40K-LV / X3-FTH-50K-LV / X3-FTH-60K-LV / X3-FTH-70K-LV
X3-FTH-75K / X3-FTH-80K / X3-FTH-100K / X3-FTH-110K
X3-FTH-120K / X3-FTH-125K / X3-FTH-136K-MV / X3-FTH-150K-MV



X3-FTH / X3-FTH LV

eManual in the QR code or at
<http://kb.solaxpower.com/>

www.solaxpower.com

Table of Contents













| | |
|---------------------|----|
| Safety..... | 1 |
| Sicherheit..... | 3 |
| Sécurité..... | 5 |
| Seguridad..... | 7 |
| Segurança | 9 |
| Veiligheid | 11 |
| Sicurezza | 13 |
| Bezpieczeństwo..... | 15 |
| Bezpečnost..... | 17 |
| Säkerhet | 19 |
| Siguranță..... | 21 |
| Безопасност | 23 |
| Sikkerhed | 25 |
| Ασφάλεια..... | 27 |
| Ohutus | 29 |
| Turvallisuus..... | 31 |
| Sigurnost..... | 33 |
| Biztonság..... | 35 |
| Sauga..... | 37 |
| Drošība..... | 39 |
| Bezpečnost..... | 41 |
| Varnost..... | 43 |
| Güvenlik..... | 45 |
| Segurança | 47 |
| Installation..... | 49 |

Safety

General Notice

1. Contents may be periodically updated or revised. SolaX reserves the right to make improvements or changes in the product(s) and the program(s) described in this manual without the prior notice.
2. The installation, maintenance and grid-related setting can only be performed by qualified personnel who:
 - Are licensed and/or satisfy state and local jurisdiction regulations;
 - Have good knowledge of this manual and other related documents.
3. Before installing the device, carefully read, fully understand and strictly follow the detailed instruction of the user manual and other related regulations. SolaX shall not be liable for any consequences caused by the violation of the storage, transportation, installation, and operation regulations specified in this document and the user manual.
4. Use insulated tools when installing the device. Individual protective tools must be worn during installation, electrical connection and maintenance.
5. Please visit the website www.solaxpower.com of SolaX for more information.

Descriptions of Labels

| | | | |
|---|--|---|---|
|  | CE mark of conformity |  | TUV certification |
|  | RCM mark of conformity |  | UKCA mark of conformity |
|  | Additional grounding point |  | Caution, hot surface |
|  | Caution, risk of electric shock |  | Caution, risk of danger |
|  | Read the enclosed documentation |  | Do not dispose of the inverter together with household waste. |
|  | Do not operate this inverter until it is isolated from mains and on-site PV generation suppliers. | | |
|  | Danger of high voltage. Do not touch live parts for 5 minutes after disconnection from the power sources. | | |

 **DANGER!****Lethal danger from electrical shock due to the inverter**

- Only operate the inverter when it is technically faultless. Otherwise, electric shock or fire may occur.
- Do not open the enclosure in any case without authorization from SolaX. Unauthorized opening will void the warranty and cause lethal danger or serious injury due to electric shock.

 **DANGER!****Lethal danger from electrical shock due to the PV**

- When exposed to sunlight, high DC voltage will be generated by PV modules. Death or lethal injuries will occur due to electric shock.
- Never touch the positive or negative pole of PV connecting device. Touching both of them at the same time is prohibited as well.
- Do not ground the positive or negative pole of the PV modules.
- Only qualified personnel can perform the wiring of the PV panels.

 **WARNING!****Risk of personnel injury or inverter damage**

- During operation, do not touch any parts other than DC switch and LCD panel of the inverter.
- Never connect or disconnect the AC and DC connectors when the inverter is running.
- Turn off the AC and DC power and disconnect them from the inverter, wait for 5 minutes to fully discharge the voltage before attempting any maintenance, cleaning or working on any circuits connected.
- Make sure that the input DC voltage \leq Maximum DC input voltage of the inverter.
- Overvoltage may cause permanent damage to the inverter, which is NOT covered by the warranty.

 **CAUTION!**

- Keep children away from the inverter.
- Pay attention to the weight of the inverter. Personal injuries may be caused if not handled properly.













NOTICE!

- If an external RCD is required by local regulations, check which type of RCD is required for relevant electric codes. It is recommended to use a Type-A RCD with the value of 300 mA.
- All the product labels and nameplate on the inverter shall be maintained clearly visible.

Allgemeiner Hinweis

1. Inhalt kann regelmäßig aktualisiert oder überarbeitet werden. SolaX behält sich das Recht vor, Verbesserungen oder Änderungen an dem/den in diesem Handbuch beschriebenen Produkt(en) und Programm(en) ohne vorherige Ankündigung vorzunehmen.
2. Die Installation, Wartung und Netz-bezogene Einstellung darf nur von qualifiziertem Personal durchgeführt werden, das:
 - als solche zugelassen sind und/oder die Vorschriften der staatlichen und lokalen Gesetzgebung erfüllen;
 - gute Kenntnisse dieses Handbuchs und anderer damit zusammenhängender Dokumente haben.
3. Lesen Sie vor der Installation des Geräts die ausführlichen Anweisungen des Benutzerhandbuchs und anderer damit zusammenhängender Vorschriften sorgfältig durch, machen Sie sich mit ihnen vertraut und befolgen Sie sie genau. SolaX haftet nicht für Folgen, die durch die Verletzung der in diesem Dokument und im Benutzerhandbuch angegebenen Lager-, Transport-, Installations- und Betriebsvorschriften entstehen.
4. Benutzen Sie bei der Installation des Geräts isolierte Werkzeuge. Bei der Installation, dem elektrischen Anschluss und der Wartung muss individuelle Schutzausrüstung getragen werden.
5. Besuchen Sie bitte die Website www.solaxpower.com von SolaX für weitere Informationen.

Beschreibungen der Etiketten

| | | | |
|---|---|---|---|
|  | CE-Kennzeichnung |  | TÜV-Zertifikat |
|  | RCM-Zeichen |  | UKCA-Zeichen |
|  | Zusätzlicher Erdungspunkt |  | Vorsicht, heiße Oberfläche |
|  | Vorsicht, Stromschlaggefahr |  | Vorsicht, Gefahrenrisiko |
|  | Lesen Sie die beigefügten Dokumente |  | Entsorgen Sie den Wechselrichter nicht mit dem Hausmüll |
|  | Betreiben Sie diesen Wechselrichter erst, wenn er vom Stromnetz und von den PV-Erzeugern vor Ort getrennt ist. | | |
|  | Hochspannungsgefahr. Berühren Sie keine stromführenden Teile für 5 Minuten nach der Trennung von den Stromquellen. | | |

GEFAHR!
Tödliche Gefahr durch Stromschlag durch den Wechselrichter

- Betreiben Sie den Wechselrichter nur, wenn er technisch einwandfrei ist. Andernfalls besteht Stromschlag- oder Brandgefahr;
- Öffnen Sie das Gehäuse auf keinen Fall ohne Genehmigung von SolaX. Eigenmächtiges Öffnen führt zum Verlust der Garantie und kann zu tödlichen Gefahren oder schweren Verletzungen durch Stromschlag führen.

GEFAHR!
Tödliche Gefahr durch Stromschlag aufgrund der PV

- Bei Sonneneinstrahlung wird von der PV-Anlage eine hohe Gleichspannung erzeugt. Tod oder tödliche Verletzungen durch Stromschlag sind die Folge.
- Berühren Sie niemals den positiven oder negativen Pol des PV-Anschlussgeräts. Auch das gleichzeitige Berühren der beiden ist untersagt.
- Erden Sie nicht den positiven oder negativen Pol der PV-Module.
- Die Verkabelung der PV-Paneele darf nur von qualifiziertem Personal durchgeführt werden.

WARNUNG!
Gefahr von Personenschäden oder Beschädigung des Wechselrichters

- Berühren Sie während des Betriebs keine anderen Teile als den Gleichstrom-Schalter und den LCD-Bildschirm.
- Verbinden oder trennen Sie niemals die AC- und DC-Verbindungen, wenn der Wechselrichter in Betrieb ist.
- Schalten Sie die Wechsel- und Gleichstromversorgung aus und trennen Sie sie vom Wechselrichter, warten Sie 5 Minuten, um die Spannung vollständig zu entladen, bevor Sie Wartungs- oder Reinigungsarbeiten durchführen oder an den angeschlossenen Stromkreisen arbeiten.
- Prüfen Sie, ob die Eingangs-Gleichspannung \leq der maximalen Eingangsspannung des Wechselrichters beträgt. Eine Überspannung kann zu dauerhaften Schäden am Wechselrichter führen, die NICHT durch die Garantie abgedeckt sind.

VORSICHT!

- Halten Sie Kinder vom Wechselrichter fern.
- Achten Sie auf das Gewicht des Wechselrichters. Bei unsachgemäßer Handhabung kann es zu Personenschäden kommen.

HINWEIS!











- Wenn ein externer FI-Schutzschalter gemäß den örtlichen Vorschriften erforderlich ist, prüfen Sie, welche Art von FI-Schutzschalter gemäß den einschlägigen Elektrovorschriften erforderlich ist. Es wird empfohlen, einen FI-Schutzschalter vom Typ A mit einem Wert von 300 mA zu benutzen.
- Alle Produktetiketten und das Typenschild des Wechselrichters müssen gut sichtbar bleiben.

Sécurité

Avis général

1. Le contenu peut être périodiquement mis à jour ou révisé. SolaX se réserve le droit d'apporter des améliorations ou des modifications au(x) produit(s) et au(x) programme(s) décrit(s) dans ce manuel sans préavis.
2. L'installation, la maintenance et le réglage lié au réseau ne peuvent être effectués que par du personnel qualifié qui:
 - sont agréés et/ou satisfont aux exigences de la réglementation nationale et locale ;
 - ont une bonne connaissance de ce manuel et des autres documents connexes.
3. Avant d'installer l'appareil, lisez attentivement, comprenez parfaitement et suivez strictement les instructions détaillées du manuel d'utilisation et d'autres réglementations connexes. SolaX ne sera pas responsable des conséquences causées par la violation de la réglementation concernant le stockage, le transport, l'installation et l'exploitation spécifiées dans ce document et le manuel d'utilisation.
4. Utiliser des outils isolés lors de l'installation de l'appareil. Des outils de protection individuels doivent être portés lors de l'installation, du raccordement électrique et de la maintenance.
5. Veuillez visiter le site Web www.solaxpower.com de SolaX pour obtenir de plus amples informations.

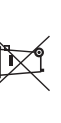
Descriptions des étiquettes

| | | | |
|---|---|---|--|
|  | Marquage CE de conformité |  | Homologation TÜV |
|  | Marquage RCM de conformité |  | Marquage UKCA de conformité |
|  | Point de mise à la terre supplémentaire |  | Attention, surface chaude |
|  | Attention, risque de choc électrique |  | Attention, risque de danger |
|  | Lire la documentation jointe |  | Ne pas jeter l'onduleur avec les ordures ménagères |
|  | Ne pas faire fonctionner cet onduleur tant qu'il n'est pas isolé du secteur et des fournisseurs de production PV sur site. | | |
|  | Risque de haute tension. Ne pas toucher pas les pièces sous tension avant un délai de 5 minutes après la déconnexion des sources d'alimentation. | | |



Danger de mort par choc électrique dû à l'onduleur

- N'exploitez l'onduleur que s'il est techniquement irréprochable. Sinon, un choc électrique ou un incendie pourrait se produire.
- Ne jamais ouvrir le boîtier sans l'autorisation de SolaX. L'ouverture non autorisée annulera la garantie et peut entraîner un danger mortel ou des blessures graves par choc électrique.



Danger de mort par choc électrique dû au PV

- Lors d'une exposition à la lumière du soleil, une tension continue élevée sera générée par le générateur photovoltaïque. La mort ou des blessures mortelles se produiront en raison d'un choc électrique.
- Ne jamais toucher le pôle positif ou négatif du dispositif de connexion PV. Il est également interdit de toucher les deux en même temps.
- Ne pas mettre à la terre le pôle positif ou négatif des modules PV.
- Seul un personnel qualifié peut effectuer le câblage des panneaux PV.



Risque de blessures corporelles ou de dommages à l'onduleur

- Pendant le fonctionnement, ne touchez aucune pièce autre que l'interrupteur CC et le panneau LCD.
- Ne jamais brancher ni débrancher les fiches CA et CC lorsque l'onduleur fonctionne.
- Coupez l'alimentation CA et CC et déconnectez-les de l'onduleur, attendez 5 minutes pour décharger complètement la tension avant de tenter toute maintenance, nettoyage ou travail sur les circuits connectés.
- S'assurer que la tension d'entrée CC soit \leq à la tension d'entrée CC nominale maximale de l'onduleur. Une surtension peut causer des dommages permanents à l'onduleur, ce qui n'est PAS couvert par la garantie.



- Tenir les enfants éloignés de l'onduleur.
- Prêter attention au poids de l'onduleur. Des blessures personnelles peuvent être causées si le produit n'est pas manipulé correctement.

PRUDENCE!

- Si un disjoncteur externe est requis par les réglementations locales, vérifiez quel type de disjoncteur est requis pour les codes électriques pertinents. Il est recommandé d'utiliser un disjoncteur de type A avec une valeur de 300 mA.
- Toutes les étiquettes de produit et la plaque signalétique de l'onduleur doivent rester clairement visibles.













Seguridad

ESPAÑOL

Aviso general

1. Los contenidos pueden actualizarse o revisarse periódicamente. SolaX se reserva el derecho de realizar cambios o mejoras en los productos y programas descritos en el presente manual sin previo aviso.
2. La instalación, el mantenimiento y la configuración relacionada con la red solo pueden ser realizados por personal cualificado que:
 - Tienen licencia o cumplen con las regulaciones de la jurisdicción estatal y local.
 - Tienen un buen conocimiento del presente manual y otros documentos relacionados.
3. Antes de instalar el dispositivo, lea con atención, comprenda bien y siga estrictamente las instrucciones detalladas del manual de usuario y otras normas relacionadas. SolaX no será responsable de las consecuencias causadas por el incumplimiento de las normas de almacenamiento, transporte, instalación y funcionamiento especificadas en este documento y el manual de usuario.
4. Utilice herramientas aisladas cuando instale el dispositivo. Se deben usar herramientas de protección individual durante la instalación, la conexión eléctrica y el mantenimiento.
5. Para obtener más información, visite el sitio web de SolaX www.solaxpower.com.

Descripciones de etiquetas

| | | | |
|---|--|---|---|
|  | Marcado CE de conformidad |  | Certificación TÜV |
|  | Marcado RCM de conformidad |  | Marcado UKCA de conformidad |
|  | Punto de conexión a tierra adicional |  | Precaución: superficie caliente |
|  | Precaución: riesgo de descarga eléctrica |  | Precaución: riesgo de peligro |
|  | Lea la documentación anexa |  | No deseche el inversor con la basura doméstica. |
|  | No utilice este inversor hasta que esté aislado de la red y equipo de suministro FV in situ. | | |
|  | Peligro de alto voltaje. No toque las partes activas durante los 5 minutos posteriores a la desconexión de las fuentes de alimentación. | | |

⚠ PELIGRO!**Peligro de muerte por descarga eléctrica a causa del inversor**

- Utilice el inversor únicamente cuando esté perfecto desde el punto de vista técnico. De lo contrario, podría producirse una descarga eléctrica o un incendio.
- En ningún caso, abra la caja sin autorización de SolaX. La apertura no autorizada anulará la garantía y puede causar peligro de muerte o lesiones graves por descarga eléctrica.

⚠ PELIGRO!**Peligro letal por descarga eléctrica debido a la FV**

- Cuando se expone a la luz solar, el conjunto FV genera una alta tensión de CC. Una descarga eléctrica conllevará lesiones letales o la muerte.
- Nunca toque ninguno de los polos del dispositivo de conexión FV. Esto incluye el polo positivo, negativo o ambos al mismo tiempo.
- No haga la toma de tierra desde el polo positivo o negativo del módulo FV.
- Solo el personal calificado puede realizar el cableado de los paneles FV.

⚠ ADVERTENCIA!**Riesgo de lesiones personales o daños en el inversor**

- Durante el funcionamiento, no toque ninguna pieza que no sea el interruptor de CC y el panel LCD.
- Nunca conecte o desconecte los conectores de CA y CC cuando el inversor esté en funcionamiento.
- Antes de realizar cualquier tarea de mantenimiento, limpieza o trabajo en los circuitos conectados, Apague la alimentación de CA y CC, y desconéctelas del inversor, espere 5 minutos para que se descargue completamente la tensión.
- Asegúrese de que la tensión de CC de entrada \leq Tensión nominal máxima de entrada de CC del inversor. La sobretensión puede provocar daños permanentes en el inversor, que NO están cubiertos por la garantía.

⚠ PRECAUCIÓN!

- Mantenga a los niños alejados del inversor
- Preste atención al peso del inversor. Si no se maneja adecuadamente, se pueden provocar lesiones personales.

AVISO!













- Si la legislación local exige un RCD externo, compruebe qué tipo de RCD es necesario para el código eléctrico pertinente. Se recomienda utilizar un RCD de tipo A con un valor de 300 mA.
- Todas las etiquetas del producto y la placa de características del inversor deberán mantenerse claramente visibles.

Segurança

Aviso geral

1. O conteúdo pode ser atualizado ou revisto periodicamente. A SolaX reserva-se ao direito de fazer melhorias ou alterações no(s) produto(s) e no(s) programa(s) descrito(s) neste manual sem aviso prévio.
2. A instalação, manutenção e configuração relacionada com a rede só podem ser executadas por pessoal qualificado que:
 - São licenciados e/ou atendem aos regulamentos da jurisdição estadual e local;
 - Têm um bom conhecimento deste manual e de outros documentos relacionados.
3. Antes de instalar o dispositivo, leia atentamente, compreenda completamente e siga rigorosamente as instruções detalhadas do manual do utilizador e outros regulamentos relacionados. A SolaX não se responsabiliza por quaisquer consequências causadas pela violação dos regulamentos de armazenamento, transporte, instalação e operação especificados neste documento e no manual do utilizador.
4. Utilize ferramentas com isolamento ao instalar o dispositivo. Os equipamentos de proteção individual devem ser usados durante a instalação, ligação elétrica e manutenção.
5. Visite o site www.solaxpower.com da SolaX para obter mais informações.

Descrições de rótulos

| | | | |
|---|---|---|---|
|  | Marca CE de conformidade |  | Certificação TUV |
|  | Marca RCM de conformidade |  | Marca UKCA de conformidade |
|  | Ponto de ligação à terra adicional |  | Cuidado! Superfície quente |
|  | Cuidado! Risco de choque elétrico |  | Cuidado! Risco de perigo |
|  | Leia a documentação incluída |  | Não descarte o inversor junto com o lixo doméstico. |
|  | Não opere este inversor até que ele esteja isolado da rede elétrica e dos painéis fotovoltaicos geradores de energia. | | |
|  | Perigo de alta tensão. Não toque nas partes energizadas por 5 minutos após a desconexão das fontes de alimentação. | | |

PERIGO!

Perigo letal de choque elétrico devido ao inversor

- Opere o inversor somente quando ele estiver tecnicamente sem falhas. Caso contrário, pode ocorrer choque elétrico ou incêndio.
- Não abra o compartimento em nenhum caso sem autorização da SolaX. A abertura não autorizada anulará a garantia e pode causar perigo letal ou ferimentos graves devido a choque elétrico.

PERIGO!

Perigo letal de choque elétrico devido ao PV

- Quando exposto à luz solar, a alta tensão CC será gerada pela série fotovoltaica. Morte ou ferimentos letais ocorrerão devido a choque elétrico.
- Nunca toque no polo positivo ou negativo do dispositivo de conexão fotovoltaica. Tocar os dois polos ao mesmo tempo também é proibido.
- Não ligue à terra o polo positivo e negativo dos módulos fotovoltaicos.
- Só pessoal qualificado pode executar a cablagem dos painéis fotovoltaicos.

AVISO!

Risco de ferimentos pessoais ou danos no inversor

- Durante a operação, não toque em nenhuma peça que não seja o interruptor CC e o painel LCD.
- Nunca conecte ou desconecte os conectores CA e CC quando o inversor estiver em funcionamento.
- Desligue a alimentação CA e CC e desconecte-as do inversor, aguarde 5 minutos para descarregar totalmente a tensão antes de realizar qualquer manutenção, limpeza ou trabalho em qualquer circuito ligado.
- Certifique-se de que a tensão CC de entrada \leq Tensão de entrada CC máxima nominal do inversor. A sobretensão pode causar danos permanentes ao inversor, que NÃO são cobertos pela garantia.

CUIDADO!

- Mantenha as crianças longe do inversor.
- Preste atenção ao peso do inversor. Ferimentos pessoais podem ser causados se o inversor não for manuseado adequadamente.













PONTA!

- Se um RCD externo for obrigatório perante a legislação local, verifique que tipo de RCD é exigido para os códigos de electricidade relevantes. Recomenda-se usar um RCD Tipo A com o valor de 300 mA.
- Todas as etiquetas do produto e a placa de identificação no inversor devem ser mantidas claramente visíveis.

Algemene kennisgeving

1. De inhoud kan periodiek worden bijgewerkt of herzien. SolaX behoudt zich het recht voor om zonder voorafgaande kennisgeving verbeteringen of wijzigingen aan te brengen in de producten en de programma's die worden beschreven in deze handleiding.
2. De installatie, het onderhoud en de aan het net gerelateerde instellingen, mogen uitsluitend worden uitgevoerd door gekwalificeerd personeel dat:
 - Gecertificeerd zijn en/of voldoen aan de nationale en lokale regelgeving;
 - Goede kennis hebben van deze handleiding en andere gerelateerde documenten.
3. Voordat u het toestel installeert, moet u de gedetailleerde instructies in de gebruikershandleiding en andere verwante regelgeving zorgvuldig lezen, volledig begrijpen en strikt opvolgen. SolaX is niet aansprakelijk voor de gevolgen van het niet naleven van de voorschriften voor opslag, transport, installatie en gebruik die in dit document en in de gebruikershandleiding worden vermeld.
4. Gebruik geïsoleerd gereedschap bij het installeren van het apparaat. Tijdens de installatie, elektrische aansluiting en onderhoud moeten individuele beschermingsmiddelen worden gedragen.
5. Ga naar de website www.solaxpower.com van SolaX voor meer informatie.

Beschrijving van de etiketten

| | | | |
|---|---|---|---|
|  | CE-markering van overeenstemming |  | TUV-certificering |
|  | RCM-markering van overeenstemming |  | UKCA-markering van overeenstemming |
|  | Extra aardingspunt |  | Opgelet, heet oppervlak |
|  | Opgelet, risico op elektrische schokken |  | Opgelet, risico op gevaar |
|  | Lees de bijgesloten documentatie |  | Gooi de omvormer niet samen met het huisvuil weg. |
|  | Gebruik deze omvormer niet totdat deze is geïsoleerd van het lichtnet en PV-generatoren ter plaatse. | | |
|  | Hoogspanningsgevaar. Raak na het loskoppelen van de stroombronnen gedurende 5 minuten geen spanningvoerende delen aan. | | |

GEVAAR!

Levensgevaar door elektrische schok vanwege de omvormer

- Gebruik de omvormer alleen als deze technisch in orde is. Als dit niet het geval is, kunnen er elektrische schokken of brand ontstaan.
- Open de behuizing in geen geval zonder toestemming van SolaX. Het zonder toestemming openen van de behuizing doet de garantie vervallen en kan levensgevaar of ernstig letsel als gevolg van elektrische schokken veroorzaken.

GEVAAR!

Levensgevaar door elektrische schok als gevolg van de PV

- Bij blootstelling aan zonlicht wordt er een hoge DC-spanning gegenereerd door de PV-array. De dood of dodelijk letsel zal zich voordoen als gevolg van elektrische schokken.
- Raak nooit de positieve of negatieve pool van het PV-aansluitapparaat aan. Het is ook verboden om beide tegelijk aan te raken.
- Aard de positieve of negatieve pool van de PV-modules niet.
- Alleen gekwalificeerd personeel mag de bedrading van de PV-panelen uitvoeren.

WAARSCHUWING!

Risico op persoonlijk letsel of beschadiging van de omvormer

- Raak tijdens bedrijf geen andere onderdelen dan de DC-schakelaar en het LCD-paneel aan.
- Als de omvormer in bedrijf is, mogen de AC- en DC-connectoren nooit worden aangesloten of losgekoppeld.
- Schakel de AC- en DC-voeding uit en koppel ze los van de omvormer, wacht 5 minuten om de spanning volledig te ontladen alvorens onderhouden uit te voeren, de omvormer te reinigen of werkzaamheden uit te voeren aan aangesloten circuits.
- Zorg ervoor dat de DC-ingangsspanning \leq maximale nominale DC-ingangsspanning van de omvormer. Overspanning kan permanente schade aan de omvormer veroorzaken. Dit wordt NIET gedekt door de garantie.

ATTENTIE!

- Houd kinderen uit de buurt van de omvormer.
- Let op het gewicht van de omvormer. Er kan persoonlijk letsel ontstaan als de omvormer niet juist wordt behandeld.

ADVIES!

- Als een externe RCD (aardlekschakelaar) vereist is door de lokale regelgeving, controleer dan welk type RCD vereist is voor relevante elektrische codes. Het wordt aanbevolen om een Type-A RCD met een waarde van 300 mA te gebruiken.
- Alle productlabels en naamplaatjes op de omvormer moeten duidelijk zichtbaar blijven.













Sicurezza

Avvisi generali

1. Il contenuto può essere soggetto periodicamente ad aggiornamenti o revisioni. SolaX si riserva il diritto di apportare migliorie o modifiche al(i) prodotto(i) e al(i) programma(i) descritti in questo manuale senza alcun preavviso.
2. L'installazione, la manutenzione e l'impostazione relativa alla rete possono essere eseguite esclusivamente da addetti qualificati, i quali:
 - sono in possesso di un'autorizzazione e/o agiscono nel rispetto delle normative nazionali e locali;
 - hanno una conoscenza approfondita di questo manuale o di altri documenti correlati.
3. Prima di installare il dispositivo, leggere attentamente, comprendere appieno e seguire scrupolosamente le istruzioni dettagliate del manuale dell'utente e le altre normative correlate. SolaX non sarà ritenuta responsabile per conseguenze che risultino dal mancato rispetto delle norme di conservazione, trasporto, installazione e funzionamento specificate in questo documento e nel manuale dell'utente.
4. Utilizzare utensili isolati nel corso dell'installazione del dispositivo. È necessario indossare dispositivi di protezione individuale durante gli interventi finalizzati all'installazione, al collegamento elettrico e alla manutenzione.
5. Si prega di visitare il sito web di SolaX www.solaxpower.com per maggiori informazioni.

ITANLIANO

Descrizioni delle etichette

| | | | |
|---|--|---|--|
|  | Marchio di conformità CE |  | Certificazione TÜV |
|  | Marchio di conformità RCM |  | Marchio di conformità UKCA |
|  | Punto di messa a terra aggiuntivo |  | Attenzione, superficie ad alta temperatura |
|  | Attenzione, rischio di folgorazione |  | Attenzione, rischio di pericolo |
|  | Leggere la documentazione in allegato |  | Non smaltire l'inverter come un normale rifiuto domestico. |
|  | Non mettere in funzione l'inverter finché non è stato isolato dalla rete e dai generatori FV in loco. | | |
|  | Pericolo di alta tensione. Non toccare parti sotto tensione nei cinque minuti successivi all'aver scollegato le fonti di alimentazione. | | |

PERICOLO!

Pericolo di morte per scosse elettriche dovute all'inverter

- Utilizzare l'inverter solo quando è tecnicamente privo di difetti. In caso contrario, potrebbe verificarsi il rischio di folgorazione o incendio.
- Non aprire l'involucro dell'inverter in alcuna circostanza senza l'autorizzazione di Solax. L'aprirlo in assenza di autorizzazione invaliderà la garanzia e può causare pericolo di morte o lesioni gravi per folgorazione.

PERICOLO!

Pericolo di morte per scosse elettriche dovute ai pannelli fotovoltaici

- Quando è esposto al sole, il generatore FV produrrà alta tensione CC; Le scosse elettriche comporteranno la morte o ferite letali.
- Non toccare il polo positivo o quello negativo del dispositivo di connessione FV; evitare, inoltre, di toccarli contemporaneamente.
- Non mettere a terra il polo positivo o quello negativo dei moduli FV.
- Solo il personale qualificato può eseguire il cablaggio dei pannelli fotovoltaici.

AVVERTENZA!

Rischio di lesioni personali o danni all'inverter

- Durante il funzionamento, non toccare parti diverse dall'interruttore CC e dal pannello LCD.
- Non collegare o scollegare connettori CA e CC quando l'inverter è in funzione.
- Spegnerne l'alimentazione CA e CC, quindi scollegarli dall'inverter, attendere cinque minuti perché la tensione si scarichi completamente, prima di procedere alla manutenzione, alla pulizia o ad interventi sui circuiti collegati.
- Assicurarsi che la tensione in ingresso CC sia pari o inferiore al valore nominale massimo dell'inverter. Una sovratensione potrebbe causare danni permanenti all'inverter non coperti da garanzia.

ATTENZIONE!

- Tenere l'inverter lontano dalla portata dei bambini.
- Tenere in considerazione il peso dell'inverter; se non viene maneggiato adeguatamente, potrebbe causare lesioni personali.

AVVISO!











- Se i regolamenti locali obbligano all'utilizzo di un RCD esterno, verificare quale sia il tipo richiesto dal codice elettrico pertinente. Si consiglia l'utilizzo di un RCD di tipo A con valori di corrente pari a 300 mA.
- Tutte le etichette e la targhetta riportate sull'inverter devono essere mantenute in modo da essere perfettamente visibili.

Bezpieczeństwo

Uwaga ogólna

1. Treść może być co pewien czas aktualizowana lub zmieniana. Firma SolaX zastrzega sobie prawo do wprowadzania ulepszeń lub zmian w produktach i programach opisanych w niniejszej instrukcji bez uprzedniego powiadomienia.
2. Instalację, konserwację i konfigurację ustawić związanych z siecią mogą przeprowadzać wyłącznie wykwalifikowani pracownicy, którzy:
 - Posiadają odpowiednią licencję i/lub spełniają wymogi określone w przepisach krajowych i lokalnych;
 - Są obeznani z treścią niniejszej instrukcji i innych powiązanych dokumentów.
3. Przed zainstalowaniem urządzenia należy uważnie przeczytać i w pełni zrozumieć szczegółowe instrukcje określone w podręczniku użytkownika oraz innych powiązanych regulacjach i ściśle się do nich stosować. Firma SolaX nie ponosi odpowiedzialności za jakiegokolwiek skutki spowodowane naruszeniem zasad przechowywania, transportu, instalacji i obsługi określonych w niniejszym dokumencie oraz instrukcji obsługi.
4. Podczas instalowania urządzenia należy korzystać z izolowanych narzędzi. Podczas instalacji, podłączenia elektrycznego i konserwacji należy nosić indywidualne środki ochrony.
5. Więcej informacji można znaleźć na stronie internetowej firmy SolaX: www.solaxpower.com.

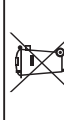
Opisy etykiet

| | | | |
|---|---|---|--|
|  | Znak zgodności CE |  | Certyfikat TUV |
|  | Znak zgodności RCM |  | Znak zgodności UKCA |
|  | Dodatkowy punkt uziemienia |  | Ostrożnie, gorąca powierzchnia |
|  | Ostrożnie, ryzyko porażenia prądem |  | Ostrożnie, ryzyko niebezpieczeństwa |
|  | Zapoznaj się z załączoną dokumentacją |  | Nie należy wyrzucać falownika razem z odpadami domowymi. |
|  | Nie należy używać tego falownika, dopóki nie zostanie on odizolowany od sieci zasilającej i dostawców energii fotowoltaicznej na miejscu. | | |
|  | Niebezpieczeństwo związane z wysokim napięciem. Nie wolno dotykać części pod napięciem przez 5 minut od momentu odłączenia od źródła zasilania. | | |

NIEBEZPIECZEŃSTWO!

Śmiertelne niebezpieczeństwo porażenia prądem z falownika

- Falownik należy obsługiwać wyłącznie, gdy jest w pełni sprawny technicznie. W przeciwnym razie może dojść do porażenia prądem lub pożaru.
- W żadnym wypadku nie wolno otwierać obudowy bez upoważnienia firmy SolaX. Nieuprawnione otwarcie spowoduje utratę gwarancji i może być spowodować śmiertelne niebezpieczeństwo lub poważne obrażenia w wyniku porażenia prądem.

NIEBEZPIECZEŃSTWO!

Śmiertelne niebezpieczeństwo porażenia prądem z instalacji fotowoltaicznej

- Pod wpływem promieniowania słonecznego w instalacji fotowoltaicznej powstaje wysokie napięcie prądu stałego. Porażenie prądem grozi śmiercią lub śmiertelnymi obrażeniami.
- Nie wolno dotykać dodatniego ani ujemnego bieguna urządzenia tążącego moduły fotowoltaiczne. Zabronione jest także dotykanie obu z nich jednocześnie.
- Nie należy uziemiać dodatniego ani ujemnego bieguna modułów fotowoltaicznych.
- Tylko wykwalifikowani pracownicy mogą wykonywać okablowanie paneli fotowoltaicznych.

OSTRZEŻENIE!

Ryzyko obrażenia ciała lub uszkodzenia falownika

- Podczas pracy nie wolno dotykać żadnych elementów innych niż przetątnik DC i panel LCD.
- Nigdy nie należy podłączać ani odłączać złączy AC i DC, gdy falownik pracuje; a także.
- Przed przystąpieniem do konserwacji, czyszczenia lub prac przy podłączonych obwodach należy Wyłączyć zasilanie AC i DC oraz odłączyć te obwody od falownika. odczekać 5 minut w celu całkowitego rozładowania napięcia.
- Upewnij się, że wejściowe napięcie prądu stałego \leq maksymalne znamionowe napięcie wejściowe prądu stałego falownika. Przepięcie może spowodować trwałe uszkodzenie falownika, które NIE jest objęte gwarancją.

PRZESTROGA!

- Nie wolno dopuszczać dzieci w pobliże falownika.
- Należy zwrócić uwagę na ciężar falownika. W przypadku niewłaściwego obchodzenia się może dojść do obrażeń ciała; ponadto.

UWAGA!













- Jeśli przepisy lokalne wymagają zastosowania zewnętrznego wyłącznika różnicowoprądowego, należy sprawdzić, jaki typ wyłącznika jest wymagany zgodnie z odpowiednimi przepisami elektrycznymi. Zaleca się stosowanie wyłącznika różnicowoprądowego RCD typu A o czułości 300 mA.
- Wszystkie etykiety produktu i tabliczka znamionowa na falowniku powinny być dobrze widoczne.

Bezpečnost

Obecné upozornění

1. Obsah může být pravidelně aktualizován nebo revidován. Společnost SolaX si vyhrazuje právo provést vylepšení nebo změny v produktech a programech popsaných v této příručce bez předchozího upozornění.
2. Instalaci, údržbu a nastavení týkající se sítě může provádět pouze kvalifikovaný personál, který:
 - je licencován a/nebo splňuje státní a místní regulační předpisy;
 - je dobře seznámen s touto příručkou a dalšími souvisejícími dokumenty.
3. Před instalací zařízení si pozorně přečtěte, plně pochopte a přísně dodržujte podrobné pokyny v uživatelské příručce a další související předpisy. Společnost SolaX nenese odpovědnost za žádné následky způsobené porušením skladovacích, přepravních, instalačních a provozních předpisů uvedených v tomto dokumentu a uživatelské příručce.
4. Při instalaci zařízení používejte izolované nástroje. Při instalaci, elektrickém připojení a údržbě je nutné nosit jednotlivé ochranné nástroje.
5. Navštivte prosím webovou stránku www.solaxpower.com společnosti SolaX pro více informací.

Popisy štítků

| | | | |
|---|--|---|---|
|  | Značka shody CE |  | Certifikace TUV |
|  | Značka shody RCM |  | Značka shody UKCA |
|  | Další bod pro uzemnění |  | Pozor, horký povrch |
|  | Pozor, nebezpečí úrazu elektrickým proudem |  | Pozor, nebezpečí |
|  | Přečtěte si příloženou dokumentaci. |  | Nelikvidujte měnič společně s domovním odpadem. |
|  | Neprovozujte tento střídač, dokud není izolován od sítě a místních dodavatelů FV generátoru. | | |
|  | Nebezpečí vysokého napětí Nedotýkejte se částí pod napětím po dobu 5 minut po odpojení od zdroje energie. | | |

NEBEZPEČÍ!

Nebezpečí smrtelného úrazu elektrickým proudem v důsledku střídače

- Měníč provzdujte pouze tehdy, je-li technicky bezvadný. Jinak může dojít k úrazu elektrickým proudem nebo požáru.
- V žádném případě neotevírejte kryt bez povolení společnosti SolaX. Neoprávněné otevření způsobí neplatnost záruky a způsobí smrtelné nebezpečí nebo vážné zranění v důsledku úrazu elektrickým proudem.

NEBEZPEČÍ!

Smrtelné nebezpečí úrazu elektrickým proudem v důsledku FV

- Při vystavení slunečnímu záření budou FV moduly generovat vysoké stejnosměrné napětí. V důsledku úrazu elektrickým proudem může dojít k usmrcení nebo smrtelnému zranění.
- Nikdy se nedotýkejte kladného nebo záporného pólu FV připojovacího zařízení. Je také zakázáno dotýkat se obou pólů současně.
- Neuzeměňujte kladný ani záporný pól FV modulů.
- Zapojení FV panelů může provádět pouze kvalifikovaný personál.

VAROVÁNÍ!

Nebezpečí zranění osob nebo poškození střídače

- Během provozu se nedotýkejte jiných částí než vypínače stejnosměrného proudu a LCD panelu.
- Nikdy nepřipojujte ani neodpojujte konektory střídavého proudu ani konektory stejnosměrného proudu, když je střídač v chodu.
- Vypněte střídavé a stejnosměrné napájení a odpojte je od střídače, počkejte 5 minut, než se napětí úplně vybijí, než se pokusíte o jakoukoli údržbu, čištění nebo práci na připojených obvodech.
- Ujistěte se, že vstupní stejnosměrné napětí \leq DC vstupní stejnosměrné napětí střídače. Přepětí může způsobit trvalé poškození měniče, na které se NEVZTAHUJE záruka.

POZOR!

- Měníč udržujte mimo dosah dětí.
- Věnujte pozornost hmotnosti měniče. Při nesprávném zacházení může dojít ke zranění osob.













OZNÁMENÍ!

- Pokud místní předpisy vyžadují externí proudový chránič, zkontrolujte, jaký typ proudového chránič je vyžadován pro příslušné elektrické kódy. Doporučuje se použít proudový chránič typu A s hodnotou 300 mA.
- Všechny produktové štítky a typový štítek na střídači musí být dobře viditelné.

Allmänt meddelande

1. Innehållet kan uppdateras eller revideras regelbundet. SolaX förbehåller sig rätten att göra förbättringar eller ändringar i produkten/produkterna och programmet/programmen som beskrivs i denna handbok utan föregående meddelande.
2. Installation, underhåll och elnätrelaterad inställning kan endast utföras av kvalificerad personal som:
 - Är licensierade och/eller uppfyller statliga och lokala jurisdiktionsbestämmelser;
 - Har god kännedom om denna handbok och andra relaterade dokument.
3. Innan du installerar enheten, läs noggrant, förstå och följ noggrant de detaljerade anvisningarna i användarhandboken och andra relaterade regler. SolaX ansvarar inte för några konsekvenser som orsakas av brott mot lagrings-, transport-, installations- och driftföreskrifterna som anges i detta dokument och användarhandboken.
4. Använd isolerade verktyg när du installerar enheten. Individuell skyddsutrustning måste bäras under installation, elektrisk anslutning och underhåll.
5. Besök webbplatsen www.solaxpower.com av SolaX för mer information.

Beskrivningar av etiketter

| | | | |
|---|---|---|--|
|  | CE-märke för överensstämmelse |  | TUV-certifiering |
|  | RCM-märke för överensstämmelse |  | UKCA-märke för överensstämmelse |
|  | Ytterligare jordningspunkt |  | Försiktighet, het yta |
|  | Försiktighet, risk för elektrisk stöt |  | Försiktighet, risk för fara |
|  | Läs bifogad dokumentation |  | Kassera inte växelriktaren tillsammans med hushållsavfallet. |
|  | Använd inte denna växelriktare förrän den är isolerad från elnätet och försörjningen från solcellsanläggningen. | | |
|  | Risk för högspänning. Rör inte vid spänningsförande delar under 5 minuter efter fränkoppling från strömkällorna. | | |



FARA!

Dödlig fara från elektriska stötar på grund av växelriktaren

- Använd endast växelriktaren när den är tekniskt felfri. Annars kan elektriska stötar eller brand uppstå.
- Öppna inte höljet under några omständigheter utan tillstånd från SolaX. Obehörig öppning upphäver garantin och orsakar dödlig fara eller allvarlig skada på grund av elektriska stötar.



FARA!

Dödlig fara från elektriska stötar på grund av solcellsanläggningen

- Vid exponering till solljus genereras hög DC-spänning av solcellsmoduler. Dödsfall eller dödliga skador kommer att uppstå på grund av elektrisk stöt.
- Rör aldrig vare sig den positiva eller negativa polen på anslutningsenheten för solcellsanläggningen. Att röra båda samtidigt är också förbjudet.
- Jorda inte den positiva eller negativa polen på solcellsmodulerna.
- Endast kvalificerad personal kan utföra inkopplingsarbete på solcellspanelerna.



VARNING!

Risk för personskada eller skador på växelriktaren

- Under drift, rör inte några andra delar än CD-omkopplare och LCD-panelen.
- Anslut eller koppla aldrig ur AC- och DC-kontakterna när växelriktaren är igång.
- Stäng av AC- och DC-försörjningen och koppla bort dem från växelriktaren, vänta i 5 minuter för att helt ladda ur spänningen innan du utför underhåll, rengöring eller arbete på anslutna kretsar.
- Se till att den ingående DC-spänning \leq maximal DC-spänning hos växelriktaren.
- Överspänning kan orsaka permanent skada på växelriktaren, som INTE täcks av garantin.



FÖRSIKTIGHET!

- Håll barn borta från växelriktaren.
- Var uppmärksam på växelriktarens vikt. Det kan leda till personskador de inte hanteras korrekt.

OBS!













- Om en extern jordfelsbrytare krävs enligt lokala bestämmelser, kontrollera vilken typ av jordfelsbrytare som krävs för relevanta elektriska bestämmelser. Det rekommenderas att använda en typ-A RCD med värdet 300 mA.
- Alla produktetiketter och typskylten på växelriktaren ska vara tydligt synliga.

Siguranță

Notă generală

1. Conținutul poate fi actualizat sau revizuit periodic. SolaX își rezervă dreptul de a aduce îmbunătățiri sau modificări produsului (produselor) și programului (programelor) descrise în acest manual fără notificare prealabilă.
2. Instalarea, întreținerea și setarea rețelei pot fi efectuate numai de personal calificat care:
 - Deține licență și/sau îndeplinește reglementările juridictionale de stat și locale;
 - Cunoaște bine acest manual și alte documente conexe.
3. Înainte de a instala dispozitivul, citiți cu atenție, înțelegeți pe deplin și urmați cu strictețe instrucțiunile detaliate din manualul de utilizare și alte reglementări aferente. Compania SolaX nu va fi responsabilă pentru nicio consecință cauzată de încălcarea regulamentelor de depozitare, transport, instalare și operare specificate în acest document și în manualul de utilizare.
4. Pentru instalarea dispozitivului, utilizați unelte izolate. În timpul instalării, conectării electrice și întreținerii trebuie purtate echipamente individuale de protecție.
5. Vizitați site-ul web www.solaxpower.com al SolaX pentru mai multe informații.

Descrierile etichetelor

| | | | |
|---|---|---|--|
|  | Marcaj de conformitate CE |  | Certificare TUV |
|  | Marcaj de conformitate RCM |  | Marcaj de conformitate UKCA |
|  | Punct suplimentar de împământare |  | Atenție, suprafață fierbinte |
|  | Atenție, risc de electrocutare |  | Atenție, risc de pericol |
|  | Citiți documentațiile anexate |  | Nu aruncați invertorul împreună cu deșeurile menajere. |
|  | Nu utilizați acest inverter până când nu este deconectat de la rețea și de la furnizorii de generare PV de la fața locului. | | |
|  | Pericol de înaltă tensiune. Nu atingeți părțile sub tensiune timp de 5 minute după deconectarea de la sursele de alimentare. | | |

PERICOL!

Pericol de deces cauzat prin electrocutare din cauza invertorului

- Utilizați invertorul numai dacă nu are defecțiuni tehnice. În caz contrar, poate apărea electrocutare sau incendiu.
- Nu deschideți în niciun caz carcasa fără autorizația SolaX. Deschiderea neautorizată va anula garanția și va cauza pericol letal sau vătămare gravă prin electrocutare.

PERICOL!

Pericol de deces prin electrocutare din cauza PV

- Atunci când sunt expuse la lumina soarelui, modulele fotovoltaice (PV) vor genera o tensiune de c.c. ridicată. Decesul sau răniile letale vor fi cauzate prin electrocutare.
- Nu atingeți niciodată polul pozitiv sau negativ al dispozitivului de conectare PV. De asemenea, este interzisă atingerea ambilor poli simultan.
- Nu împământați polul pozitiv sau negativ al modulelor fotovoltaice (PV).
- Numai personalul calificat poate efectua cablarea panourilor fotovoltaice (PV).

AVERTIZARE!

Risc de rănire a personalului sau deteriorare a invertorului

- În timpul funcționării, nu atingeți alte părți, cu excepția comutatorului de c.c. și a panoului LCD.
- Nu conectați sau deconectați niciodată conectorii de c.a. și c.c. când invertorul funcționează.
- Oprțiți alimentarea c.a. și c.c. și deconectați-le de la invertor, așteptați 5 minute pentru a descărca complet tensiunea înainte de a încerca orice întreținere, curățare sau lucrare la orice circuit conectat.
- Asigurați-vă că tensiunea de intrare de c.c. \leq Tensiunea maximă de intrare c.c. a invertorului. Supratensiunea poate cauza deteriorarea permanentă a invertorului, care NU este acoperită de garanție.

ATENȚIE!

- Nu lăsați copiii în apropierea invertorului.
- Fiți atenți la greutatea invertorului. Dacă nu este manipulat corespunzător, pot fi cauzate vătămări personale.

NOTĂ!













- Dacă reglementările locale impun un RCD extern, verificați ce tip de RCD este necesar pentru codurile electrice relevante. Se recomandă utilizarea unui RCD tip A cu valoarea de 300 mA.
- Toate etichetele produselor și plăcuța de identificare de pe invertor trebuie să fie menținute vizibile clar.

Безопасност

Общи положения

1. Съдържанието може да се обновява или ревизира периодически. SolaX си запазва правото да прави подобрения или промени в продукта (продуктите) и програмата (програмите), описани в това ръководство, без предизвестие.
2. Монтажът, обслужването и свързването с електрическата мрежа следва да се извършват само от квалифицирани техници, които:
 - Притежават съответния лиценз и/или отговарят на държавните или общинските изисквания;
 - Познават добре това ръководство и свързаната документация.
3. Преди монтажа на устройството трябва да прочетете внимателно, да разберете напълно и да спазвате стриктно подробните инструкции на ръководството за потребителя и свързаните разпоредби. SolaX не носи отговорност за никакви последиствия, причинени от неспазване на инструкциите за съхранение, транспортирание, монтаж и експлоатация, посочени в този документ и в ръководството за потребителя.
4. Използвайте изолирани инструменти за монтажа на устройството. Носете лични предпазни средства по време на монтажа, електрическото свързване и обслужването.
5. Посетете уеб сайта на SolaX www.solaxpower.com за повече информация.

Описание на стикерите

| | | | |
|---|--|---|--|
|  | CE маркировка за съответствие |  | TUV сертификация |
|  | RCM маркировка за съответствие |  | UKCA маркировка за съответствие |
|  | Допълнителна точка за заземяване |  | Внимание - гореща повърхност |
|  | Внимание - риск от токов удар |  | Внимание - риск от опасност |
|  | Прочетете приложената документация |  | Не изхвърляйте инвертора заедно с битовите отпадъци. |
|  | Не работете с инвертора, докато не бъде разединен от мрежата и от локалните PV системи. | | |
|  | Опасност от високо напрежение. Не докосвайте тоководещи части 5 минути след изключване на захранването. | | |

ОПАСНОСТ!

Смъртоносна опасност от токов удар

- Използвайте инвертора само когато е технически изправен. В противен случай има риск от токов удар или пожар.
- При никакви обстоятелства не отваряйте корпуса без разрешение от SolaX. Неоторизираното отваряне на корпуса ще анулира гаранцията и ще доведе до смъртоносна опасност или сериозна травма поради токов удар.

ОПАСНОСТ!

Смъртоносна опасност от токов удар при контакт с PV

- При излагане на слънчева светлина PV модулите генерират високо правотоково напрежение. Токовият удар ще доведе до смърт или смъртоносни травми.
- Никога не докосвайте положителния или отрицателния полюс на устройството за свързване към PV. Забранява се също двата полюса да се пипат едновременно.
- Не заземявайте положителния и отрицателния полюс на PV модулите.
- Само квалифицирани техници могат да работят по електрическата инсталация на PV панелите.

ПРЕДУПРЕЖДЕНИЕ!

Риск от физическа травма или повреда на инвертора

- По време на работа не пипайте никакви други части освен DC превключвателя и LCD панела.
- Никога не включвайте и не изключвайте AC и DC конекторите, докато инверторът работи.
- Изключете променливотоковото и правотоковото захранване, разкачете ги от инвертора и изчакайте 5 минути напрежението да изчезне напълно, преди да пристъпите към обслужване, почистване или друга работа по свързаните вериги.
- Уверете се, че входното правотоково напрежение е \leq на максималното правотоково входно напрежение на инвертора. Свърхнапрежението може да повреди трайно инвертора, а това НЕ се покрива от гаранцията.

ВНИМАНИЕ!

- Не допускате деца в близост до инвертора.
- Имате предвид теглото на инвертора. Неправилната работа може да доведе до злополуки.

БЕЛЕЖКА!













- Ако местните разпоредби изискват да се използва външна ДТЗ, проверете какъв тип ДТЗ се изисква за съответните електрически кодове. Препоръчва се да се използва ДТЗ тип А със стойност 300 mA.
- Всички стикери и заводската табелка на инвертора трябва да се поддържат чисти.

Sikkerhed

Generel meddelelse

1. Indholdet kan blive opdateret eller revideret regelmæssigt. SolaX forbeholder sig retten til at foretage forbedringer eller ændringer i produktet/produkterne og programmerne beskrevet i denne manual uden forudgående varsel.
2. Installation, vedligeholdelse og netrelateret indstilling kan kun udføres af kvalificeret personale, som:
 - Er licenseret og/eller opfylder statslige og lokale jurisdiktionsregler
 - Har godt kendskab til denne manual og andre relaterede dokumenter.
3. Før du installerer enheden, skal du omhyggeligt læse, forstå og nøje følge den detaljerede vejledning i brugervejledningen og andre relaterede regler. SolaX hæfter ikke for eventuelle konsekvenser forårsaget af overtrædelse af opbevarings-, transport-, installations- og betjeningsreglerne specificeret i dette dokument og brugervejledningen.
4. Brug isoleret værktøj, når du installerer enheden. Individuelt beskyttelsesværktøj skal benyttes under installation, elektrisk tilslutning og vedligeholdelse.
5. Besøg venligst hjemmesiden www.solaxpower.com for SolaX for mere information.

Mærkatbeskrivelser

| | | | |
|---|---|---|---|
|  | CE-overensstemmelsesmærke |  | TÜV-certificering |
|  | RCM-overensstemmelsesmærke |  | UKCA-overensstemmelsesmærke |
|  | Ekstra jordingspunkt |  | Forsigtig, varm overflade |
|  | Forsigtig, risiko for elektrisk stød |  | Forsigtig, risiko for fare |
|  | Læs den vedlagte dokumentation |  | Bortskaf ikke veksleretteren sammen med husholdningsaffald. |
|  | Bejten ikke denne veksleretter, før den er isoleret fra lysnettet og PV-generende moduler på stedet. | | |
|  | Højspændingsfare Rør ikke ved spændingsførende dele i 5 minutter efter frakobling fra strømkilderne. | | |



FARE!

Livsfare på grund af elektrisk stød fra vekselretteren

- Vekselretteren må kun betjenes, når den er teknisk fejlfri. I modsat fald kan der opstå elektrisk stød eller brand.
- Kabinettet må under ingen omstændigheder åbnes uden forudgående godkendelse fra SolaX. Uautoriseret åbning vil ugyldiggøre garantien og forårsage livsfare eller alvorlig skade på grund af elektrisk stød.



FARE!

Livsfare på grund af elektrisk stød fra PV-modulet

- Når PV-moduler udsættes for sollys, genereres der høj jævnstrømsspænding. Elektrisk stød kan forårsage dødsfald eller livstruende kvæstelser.
- Rør aldrig ved den positive eller negative pol på PV-tilslutningsenheden. Det er også forbudt at berøre dem begge på samme tid.
- Forbind ikke den positive eller negative pol på PV-modulerne til jord.
- Kun kvalificeret personale kan udføre PV-panelernes ledningsføring.



ADVARSEL!

Risiko for personskade eller skade på vekselretteren

- Under drift må du ikke røre ved andre dele end jævnstrømsafbryderen (DC) og LCD-panelet.
- Tilslut eller frakobl aldrig vekselstrøms- (AC) og jævnstrømsstikkene (DC), når vekselretteren kører.
- Sluk for AC- og DC-strømmen, og afbryd dem fra vekselretteren, vent i 5 minutter for at aflade spændingen helt, før du forsøger at udføre vedligeholdelse, rengøring eller arbejde på tilsluttede kredsløb.
- Sørg for, at DC-indgangsspændingen \leq Maksimal DC-indgangsspænding for vekselretteren, Overspænding kan forårsage permanent skade på vekselretteren, hvilket IKKE er dækket af garantien.



FORSIGTIG!

- Hold børn væk fra vekselretteren.
- Vær opmærksom på vekselretterens vægt. Der kan opstå personskade, hvis den ikke håndteres korrekt.

BEMÆRK!













- Hvis en ekstern fejlstrømsafbryder er påkrævet i henhold til lokale regler, skal du kontrollere, hvilken type fejlstrømsafbryder, der kræves til relevante elforskrifter. Det anbefales at bruge en Type-A-fejlstrømsenhed med en værdi på 300 mA.
- Alle produktetiketter og navneskilt på vekselretteren skal altid være klart synlige.

Ασφάλεια

Γενικές ειδοποιήσεις

1. Τα περιεχόμενα μπορεί να ενημερώνονται ή να αναθεωρούνται περιοδικά. Η SolaX διατηρεί το δικαίωμα να προχωρήσει σε βελτιώσεις ή αλλαγές στο προϊόν(τα) και το πρόγραμμα(τα) που περιγράφονται σε αυτό το εγχειρίδιο χωρίς προηγούμενη ειδοποίηση.
2. Η εγκατάσταση, συντήρηση και η τοποθέτηση που σχετίζονται με το πλέγμα μπορούν να πραγματοποιηθούν μόνο από εξειδικευμένο προσωπικό που:
 - Διαθέτει άδεια και/ή πληροί τους κανονισμούς της πολιτείας και των τοπικών αρμόδιων.
 - Έχει καλή γνώση αυτού του εγχειριδίου και άλλων σχετικών εγγράφων.
3. Πριν από την εγκατάσταση της συσκευής, διαβάστε προσεκτικά, κατανοήστε πλήρως και τηρήστε πιστά τις σχετικές οδηγίες του εγχειριδίου χρήσης και άλλων σχετικών κανονισμών. Η SolaX δεν φέρει ευθύνη για οποιεσδήποτε συνέπειες προκαλούνται από παραβίαση των κανονισμών φύλαξης, μεταφοράς, εγκατάστασης και λειτουργίας που ορίζονται σε αυτό το έγγραφο και το εγχειρίδιο χρήσης.
4. Χρησιμοποιήστε μονωμένα εργαλεία κατά την εγκατάσταση της συσκευής. Τα ατομικά εργαλεία προστασίας πρέπει να φοριούνται κατά την εγκατάσταση, ηλεκτρική σύνδεση και συντήρηση.
5. Επισκεφθείτε τον ιστότοπο www.solaxpower.com της SolaX για περισσότερες πληροφορίες.

Περιγραφές ετικετών

|  | Σήμανση συμμόρφωσης CE |  | Πιστοποίηση TÜV |
|---|--|---|---|
|  | Σήμανση συμμόρφωσης RCM |  | Σήμανση συμμόρφωσης UKCA |
|  | Πρόσθετο σημείο γείωσης |  | Προσοχή, καυτή επιφάνεια |
|  | Προσοχή, πιθανότητα ηλεκτροπληξίας |  | Προσοχή, κίνδυνος |
|  | Διαβάστε τα εσώκλειστα έγγραφα |  | Μην απορρίπτετε το inverter μαζί με τα οικιακά απορρίμματα. |
|  | Μην λειτουργείτε αυτό το inverter έως ότου απομονωθεί από το ρεύμα και από τους παρόχους παραγωγής PV στον χώρο. | | |
|  | Κίνδυνος υψηλής τάσης. Μην αγγίζετε τα ηλεκτροφόρα μέρη για 5 λεπτά μετά την αποσύνδεση από τις πηγές ρεύματος. | | |

ΚΙΝΔΥΝΟΣ!

Θανάσιμος κίνδυνος από ηλεκτροπληξία λόγω του inverter

- Χρησιμοποιείτε το inverter μόνο όταν δεν έχει τεχνικά σφάλματα. Διαφορετικά, υπάρχει πιθανότητα ηλεκτροπληξίας ή πυρκαγιάς.
- Μην ανοίγετε το κάλυμμα σε καμία περίπτωση χωρίς έγκριση από τη SolarX. Μην εξουσιοδοτημένο άνοιγμα θα ακυρώσει την εγγύηση και να προκαλέσει θανάσιμο κίνδυνο ή σοβαρό τραυματισμό λόγω ηλεκτροπληξίας.

ΚΙΝΔΥΝΟΣ!

Θανάσιμος κίνδυνος από ηλεκτροπληξία λόγω του PV

- Κατά την έκθεση σε ηλιακό φως, υψηλή τάση DC θα παραχθεί από τις μονάδες PV. Θάνατος ή θανάσιμοι τραυματισμοί λόγω ηλεκτροπληξίας.
- Ποτέ μην αγγίζετε τον θετικό ή αρνητικό πόλο της συσκευής σύνδεσης PV. Επίσης, απαγορεύεται το ταυτόχρονο άγγιγμα και των δύο πόλων.
- Μη γειώνετε τον θετικό ή αρνητικό πόλων των μονάδων PV.
- Μόνο εξειδικευμένο προσωπικό μπορεί να πραγματοποιήσει την καλωδίωση των πάνελ PV.

ΠΡΟΕΙΔΟΠΟΙΗΣΗ!

Κίνδυνος τραυματισμού προσωπικού ή βλάβη στο inverter

- Κατά τη λειτουργία, μην αγγίζετε κανένα μέρος εκτός από τον διακόπτη DC, το πάνελ LCD.
- Ποτέ μη συνδέετε ή αποσυνδέετε τις συνδέσεις AC και DC όταν το inverter λειτουργεί.
- Απενεργοποιήστε το ρεύμα AC και DC και αποσυνδέστε τα από το inverter, περιμένετε 5 λεπτά ώστε η τάση να αποφορτιστεί πλήρως πριν επιχειρήσετε οποιαδήποτε συντήρηση, καθαρισμό ή εργασία σε οποιοδήποτε συνδεδεμένο κύκλωμα.
- Βεβαιωθείτε ότι η τάση DC εισόδου \leq Μέγιστη τάση εισόδου DC του inverter. Η υπέρταση μπορεί να προκαλέσει μόνιμη βλάβη στο inverter, η οποία ΔΕΝ καλύπτεται από την εγγύηση.

ΠΡΟΣΟΧΗ!

- Κρατήστε τα παιδιά μακριά από το Inverter.
- Προσέξτε το βάρος του inverter. Υπάρχει πιθανότητα προσωπικών τραυματισμών σε περίπτωση σφραγμένου χειρισμού.

ΕΙΔΟΠΟΙΗΣΗ!













- Εάν απαιτείται εξωτερικό RCD από τους τοπικούς κανονισμούς, ελέγξτε ποιος τύπος RCD απαιτείται για σχετικούς ηλεκτρικούς κωδικούς. Συνιστάται να χρησιμοποιείται Τύπος-A-RCD με την τιμή 300mA.
- Όλες οι ετικέτες προϊόντων και ταμπέλες επάνω στο Inverter θα παραμείνουν ξεκάθαρα ορατές.

Ohutus

Üldised märkused

1. Sisu võidakse perioodiliselt ajakohastada või läbi vaadata. SolaX jätab endale õiguse teha selles juhendis kirjeldatud tootes (toodetes) ja programmi(de)s parandusi või muudatusi ilma eelneva etteteatamiseta.
2. Paigaldamist, hooldust ja võrguga seotud seadistamist võivad teha ainult kvalifitseeritud töötajad, kes:
 - on litsentseeritud ja/või vastavad riiklikele ja kohalikele õiguseeskirjadele;
 - tunnevad hästi käesolevat kasutusjuhendit ja muid sellega seotud dokumente.
3. Enne seadme paigaldamist lugege hoolikalt läbi, saage täielikult aru ja järgige rangelt kasutusjuhendi üksikasjalikke suuniseid ja muid seonduvaid eeskirju. SolaX ei vastuta tagajärgede eest, mis tulenevad käesolevas dokumendis ning kasutusjuhendis sätestatud ladustamis-, transpordi-, paigaldus- ja käitamismuudatuste eiramisest.
4. Kasutage seadme paigaldamisel isoleeritud tööriistu. Paigaldamise, elektrilise ühendamise ja hoolduse ajal tuleb kanda isikukaitsevahendeid.
5. Lisateavet leiate SolaXi veebilehelt www.solaxpower.com.

Tähiste kirjeldused

| | | | |
|---|---|---|---|
|  | CE-vastavusmärk |  | TÜV sertifikaat |
|  | RCM-vastavusmärk |  | UKCA-vastavusmärk |
|  | Täiendav maanduspunkt |  | Ettevaatust, kuum pind |
|  | Ettevaatust, elektrilöögi oht |  | Ettevaatust, oht |
|  | Lugege lisatud dokumente |  | Ärge visake inverterit ära koos olmejäätmetega. |
|  | Ärge kasutage inverterit enne, kui see on isoleeritud vooluvõrgust ja kohapealsetest päikeseenergia tootjatest. | | |
|  | Kõrgepinge oht. Ärge puudutage pinge all olevaid osi 5 minuti jooksul pärast vooluvõrgust lahtühendamist. | | |



OHT!

Inverterist tulenev surmav elektrilöögi oht

- Kasutage inverterit ainult siis, kui see on tehniliselt töökorras. Muidu võib tekkida elektrilöök või tulekahju.
- Ärge mingil juhul avage korpust ilma SolaXi loata. Ilma loata avamine muudab garantii kehtetuks ja põhjustab elektrilöögi tõttu surmaohtu või raskeid vigastusi.



OHT!

Päikeseenergiast tingitud surmav elektrilöögi oht

- Kui PV moodulid puutuvad kokku päikesevalgusega, tekib kõrge alalisvoolupinge. Elektrilöök võib põhjustada surma või surmavaid vigastusi.
- Ärge kunagi puudutage PV ühendusadme positiivset või negatiivset poolust. Samuti on keelatud puudutada mõlemaid korraga.
- Ärge maandage PV moodulite positiivset või negatiivset poolust.
- PV paneelide juhtmestikuga võib töötada ainult kvalifitseeritud personal.



HOIATUS!

Töötajate vigastuste või inverteri kahjustamise oht

- Arge puudutage tootamise ajal muid osi peale alalisvoolu lüliti ja LCD-paneeli.
- Ärge kunagi ühendage ega lahutage vahelduv- ega alalisvooluühendusi inverteri töötamise ajal.
- Lülitage vahelduv- ja alalisvoolu toide välja ning ühendage need inverterist lahti, oodake 5 minutit, et pinge täielikult tühjeneks, enne kui püüate teha hooldustöid, puhastamist või tööd ühendatud vooluahelate kallal.
- Veenduge, et inverteri sisend-alalispinge \leq maksimaalne sisend-alalispinge. Ülepinge võib põhjustada inverterile püsivaid kahjustusi, mida garantii EI kata.



HOIATUS!

- Hoidke lapsed inverterist eemal.
- Pöörake tähelepanu inverteri kaalule. Nõuete eiramine võib põhjustada kehavigastusi.

TÄHELEPANU!













- Kui kohalikud eeskirjad nõuavad välist kaitselüliti, kontrollige, millist tüüpi kaitselüliti asjaomased elektrieskirjad nõuavad. Soovitatav on kasutada A-tüüpi kaitselüliti väärtusega 300 mA.
- Kõik inverteril olevad tootesildid ja nimesildid peavad olema selgelt nähtavad.

Turvallisuus

Yleinen ilmoitus

1. Sisältöä saatetaan päivittää tai muuttaa ajoittain. SolaX varaa oikeuden tehdä parannuksia ja muutoksia tässä oppaassa kuvattuihin tuotteisiin ja ohjelmiin ilman ennakoilmoitusta.
2. Asennus, huolto ja sähköverkkoon liittyvät asetukset on annettava sellaisen pätevän henkilöstön hoidettavaksi, joka täyttää seuraavat vaatimukset:
 - on lisensoitu ja/tai täyttää osavaltion ja paikallisen lainsäädännön vaatimukset
 - tuntee tämän oppaan ja muut aiheeseen liittyvät asiakirjat hyvin
3. Ennen kuin asennat laitteen, lue käyttöohjeen yksityiskohtaiset ohjeet ja muut aiheeseen liittyvät säännökset huolella, ymmärrä ne täysin ja noudata niitä tarkkaan. SolaX ei ole vastuussa mistään seuraamuksista, jotka johtuvat tämän asiakirjan ja käyttöoppaan säilytys-, kuljetus-, asennus- ja käyttöohjeiden rikkomisesta.
4. Käytä laitetta asentaessasi eristettyjä työkaluja. Asennuksen, sähkökytkentöjen ja huollon aikana on käytettävä henkilökohtaisia suojaavia työkaluja.
5. Lisätietoja on SolaXin sivustolla www.solaxpower.com.

Kyittien kuvaukset

| | | | |
|---|--|---|---|
|  | CE-vaatimustenmukaisuusmerkki |  | TUV-sertifikaatti |
|  | RCM-vaatimustenmukaisuusmerkki |  | UKCA-vaatimustenmukaisuusmerkki |
|  | Ylimääräiset maadoituskohdat |  | Varoitus, kuuma pinta |
|  | Huomio, sähköiskun vaara |  | Huomio, vaaran mahdollisuus |
|  | Lue mukana tulevat asiakirjat |  | Älä hävitä invertteritä kotitalousjätteen mukana. |
|  | Älä käytä tätä invertteritä, ennen kuin se on eristetty verkkovirrasta ja paikan päällä sijaitsevista aurinkosähkötoimittajista. | | |
|  | Suurjännitteen vaara. Älä kosketa sähköistettyjä osia 5 minuuttiin laitteen irrottamisesta virtalähteestä. | | |



VAARA!

Hengenvaara invertteristä aiheutuvan sähköiskun vaaran takia

- Käytä invertteriä vain, kun se on teknisesti moitteeton. Muutoin seurauksena voi olla sähköisku tai tulipalo.
- Älä avaa koteloa missään tapauksessa ilman SolaX:n lupaa. Luvaton avaaminen mitätöi takuun ja voi aiheuttaa hengenvaaran tai vakavan vamman sähköiskun takia.



VAARA!

Hengenvaara PV:stä aiheutuvan sähköiskun vaaran takia

- Auringon valolle altistuessaan PV-moduuleissa syntyy korkea tasajännite. Sähköisku aiheuttaa kuoleman tai hengenvaarallisen vamman.
- Älä koskaan kosketa PV-liitäntälaitteen positiivista tai negatiivista napaa. Molempien koskettaminen yhtä aikaa on myös kielletty.
- Älä maadoita PV-moduulien positiivista tai negatiivista napaa.
- Vain pätevä henkilöstö voi kytkeä PV-paneelit.



VAROITUS!

Loukkaantumisen tai invertterin vahingoittumisen vaara

- Älä kosketa käytön aikana mitään muita osia kuin DC-kytkintä ja LCD-paneelia.
- Älä koskaan kytke tai irrota AC- ja DC-liittämiä invertterin ollessa käynnissä.
- Kytke AC- ja DC-virta pois päältä ja irrota ne invertteristä ja odota 5 minuuttia, jotta jännite purkautuu täysin, ennen kuin yrität huoltaa, puhdistaa tai käsitellä mitään kytkettyjä piirejä.
- Varmista, että tulotasajännite \leq invertterin suurin tulotasajännite. Ylijännite voi aiheuttaa invertterille pysyviä vaurioita, joita takuu EI kata.



HUOMIO!

- Pidä lapset kaukana invertteristä.
- Huomioi invertterin paino. Virheellisestä käsittelystä voi seurata loukkaantumisia.

HUOMAUTUS!













- Jos paikalliset määräykset edellyttävät ulkoista vikavirtasuojaa, tarkista, minkä tyyppinen vikavirtasuojia asianmukaisissa sähkösäätännöksissä vaaditaan. Suosittelemme käyttämään A-tyyppiä 300 mA:n vikavirtasuojaa.
- Kaikki invertterin tuotemerkinnät ja nimikielpi on pidettävä selkeästi näkyvillä.

Sigurnost

Opća obavijest

1. Sadržaj se može povremeno ažurirati ili mijenjati. Tvrтка SolaX zadržava pravo izvršiti poboljšanja ili izmjene na proizvodima i programima opisanim u ovom priručniku bez prethodne obavijesti.
2. Ugradnju, održavanje i postavljanje u vezi s mrežom smije vršiti samo kvalificirano osoblje koje:
 - ima licencu i/ili udovoljava propisima u državnoj i lokalnoj nadležnosti;
 - dobro poznaje ovaj priručnik i druge povezane dokumente.
3. Prije ugradnje uređaja pažljivo pročitajte, u potpunosti usvojite i strogo slijedite podrobne upute korisničkog priručnika i druge povezane propise. Tvrтка SolaX nije odgovorna ni za koje posljedice prouzročene kršenjem propisa o skladištenju, prijevozu, ugradnji i rukovanju koji su navedeni u ovom dokumentu i korisničkom priručniku.
4. Pri ugradnji uređaja upotrebljavajte izolirane alate. Obvezno je nošenje osobne zaštitne opreme pri ugradnji, priključivanju električne energije i održavanju.
5. Za više informacija posjetite web-mjesto tvrtke SolaX: www.solaxpower.com.

Opisi oznaka

| | | | |
|---|--|---|--|
|  | Oznaka sukladnosti CE |  | Certifikacija TÜV |
|  | Oznaka sukladnosti RCM |  | Oznaka sukladnosti UKCA |
|  | Dodatno mjesto uzemljenja |  | Oprez, vruća površina |
|  | Oprez, rizik od strujnog udara |  | Oprez, rizik od opasnosti |
|  | Pročitajte priloženu dokumentaciju |  | Ne odlažite izmjenjivač zajedno s kućanskim otpadom. |
|  | Ne rukujte ovim izmjenjivačem sve dok ne bude izoliran s mrežnog napajanja i dovoda fotonaponske energije na lokaciji. | | |
|  | Opasnost od visokog napona. Ne dodirujte dijelove pod naponom 5 minuta nakon isključivanja s izvora energije. | | |

OPASNOST!

Smrtonosna opasnost od strujnog udara pri uporabi izmjenjivača

- Rukujte izmjenjivačem samo kada je potpuno tehnički ispravan. U suprotnom može doći do strujnog udara ili požara.
- Ni u kojem slučaju ne otvarajte kućište bez odobrenja tvrtke SolaX. Neovlašteno otvaranje poništava jamstvo te može prouzročiti smrtonosnu opasnost ili tešku ozljedu uslijed strujnog udara.

OPASNOST!

Smrtonosna opasnost od strujnog udara pri uporabi fotonaponske energije

- Kada su izloženi sunčevoj svjetlosti, fotonaponski moduli proizvode istosmjernu struju visokog napona. Uslijed strujnog udara doći će do smrti ili smrtonosnih ozljeda.
- Nikada ne dodirujte pozitivni ili negativni pol uređaja za fotonaponski priključak. Zabranjeno je i istovremeno dodirivanje oba pola.
- Nemojte uzemljivati pozitivni ili negativni pol fotonaponskih modula.
- Ožičavanje fotonaponskih ploča može provoditi samo kvalificirano osoblje.

UPOZORENJE!

Rizik od ozljeđivanja osoblja ili oštećenja izmjenjivača

- Tijekom rada nemojte dodirivati nijedan dio izmjenjivača osim prekidača istosmjerne struje i LCD ploče.
- Nikada nemojte uključivati ili isključivati priključke izmjenične i istosmjerne struje dok izmjenjivač radi.
- Prije početka svakog održavanja, čišćenja ili rada na bilo kojem priključenom strujnom krugu, isključite izmjenično i istosmjerno napajanje i isključite ih s izmjenjivača te pričekajte 5 minuta kako bi se napon potpuno ispraznio.
- Vodite računa da je ulazni napon istosmjerne struje \leq maksimalnim ulaznim naponom istosmjerne struje na izmjenjivaču. Prenapon može prouzročiti trajno oštećenje izmjenjivača, a ono NIJE obuhvaćeno jamstvom.

OPREZ!

- Držite djecu podalje od izmjenjivača.
- Obratite pozornost na težinu izmjenjivača. Ako se njime ne rukuje ispravno, može doći do tjelesnih ozljeda.













OBAVIJEST!

- Ako lokalni propisi zahtijevaju vanjski RCD, provjerite koji tip RCD-a je potreban za odgovarajuće električne značajke. Preporučuje se koristiti se RCD-om tipa A s vrijednošću od 300 mA.
- Sve oznake proizvoda i natpisna pločica izmjenjivača moraju biti jasno vidljive.

Általános tájékoztató

1. A tájékoztató tartalma időről időre frissülhet vagy átdolgozásra kerülhet. A SolaX fenntartja a jogot az ebben a kézikönyvben ismertetett termék(ek) és a program(ok) előzetes értesítés nélkül történő javítására.
2. A telepítést, karbantartást és a hálózattal kapcsolatos beállításokat kizárólag olyan képesített személyzet végezheti, amely:
 - az állami és helyi engedéllyel rendelkezők és/vagy jogszabályok előírásainak megfelelnek;
 - ezt a kézikönyvet és az egyéb kapcsolódó dokumentumokat jól ismerik.
3. A készülék telepítése előtt gondosan olvassa el, értelmezze teljes mértékben és szigorúan kövesse a felhasználói kézikönyv és egyéb kapcsolódó szabályozások részletes utasításait. A SolaX nem köteles helytállni az ebben a dokumentumban és a felhasználói kézikönyvben meghatározott tárolási, szállítási, telepítési és üzemeltetési szabályok megszegésével okozott semmilyen következményért.
4. A készülék telepítése során szigetelt szerszámokat használjon. A telepítés, az elektromos bekötés és a karbantartás elvégzése során kötelező egyéni védőeszközt viselni.
5. Bővebb tájékoztatásért keresse fel a SolaX honlapját a www.solaxpower.com címen.

Címkék ismertetése

| | | | |
|---|--|---|---|
|  | CE megfelelőségi jelzés |  | TÜV tanúsítvány |
|  | RCM megfelelőségi jelzés |  | UKCA megfelelőségi jelzés |
|  | További földelési pont |  | Vigyázat, forró felület |
|  | Vigyázat, áramütés veszélye |  | Vigyázat, veszély kockázata |
|  | Olvassa el a mellékelt dokumentációkat |  | Az invertert ne háztartási hulladékkal ártalmatlanítsa. |
|  | Az invertert csak akkor üzemeltesse, ha már elszigetelte a fő áramellátástól és a telephelyi PV generátoroktól. | | |
|  | Nagyfeszültség veszélye. Az áramellátásról való leválasztást követően 5 percig ne érjen az élesüzemi részekhez. | | |

 **VESZÉLY!**
Az inverter miatt a halálos áramütés veszélye áll fenn

- Az invertert kizárólag akkor üzemeltesse, ha műszakilag hibátlan. Egyébként áramütésre vagy tüzre kerülhet sor.
- A nyílást a SolaX engedélye nélkül semmilyen esetben ne nyissa ki. Az engedély nélküli nyitás a jótállás érvénytelenségét eredményezi, és áramütés miatt halálos veszélyt vagy súlyos sérülést okozhat.

 **VESZÉLY!**
A PV miatt a halálos áramütés veszélye áll fenn

- Napfénynek kitéve a PV modulok nagy egyenáramú feszültséget generálnak. Áramütés miatt halál vagy halálos sérülés következhet be.
- A PV csatlakoztató eszköz pozitív vagy negatív pólusát soha ne érintse meg. Ugyancsak tilos egyszerre megérinteni a kettőt.
- Ne földelje a PV modulok pozitív vagy negatív pólusát.
- A PV panelek vezetékezését kizárólag képzett személy végezheti.

 **VIGYÁZAT!**
Személyi sérülés vagy az inverter károsodásának kockázata

- Üzemelés során kizárólag az inverter DC csatlakozójához és LDC paneléhez érhet hozzá.
- Az inverter üzemelése közben soha ne csatlakoztassa vagy váltsa le a váltóáramú és egyenáramú csatlakozókat.
- Kapcsolja ki a váltó- és egyenáramú tápellátást és váltsa le az inverterről, várjon 5 percet a feszültség teljes kikapcsolásáig, és csak ezt követően próbálja meg a karbantartási, tisztítási vagy bármely csatlakozó áramkörön végzendő munkát megkezdni.
- Győződjön meg róla, hogy a bemenő egyenáramú feszültség legalább egyenlő az inverter maximális egyenáramú bemenő feszültségével. A túlfeszültség az inverter tartós károsodását okozhatja, amelyre a jótállás NEM vonatkozik.

 **VIGYÁZAT!**

- A gyermekeket tartsa távol az invertertől.
- Figyelje az inverter súlyát. A nem megfelelő kezelés személyi sérülést okozhat.













FIGYELEM!

- Ha a helyi szabályozások külső érintésvédelmi relé alkalmazását írják elő, ellenőrizze, milyen típusú érintésvédelmi berendezésre van szükség a vonatkozó elektromos szabályozások szerint. Javasolt 300 mA értékű A típusú érintésvédelmi relét alkalmazni.
- Az inverter összes termékcímkejét és adattábláját mindig jól láthatóan kell karbantartani.

Bendroji pastaba

1. Turinys gali būti periodiškai atnaujinamas arba peržiūrimas. „SolaX“ pasilieka teisę tobulinti ar keisti šiame vadove aprašytą (-us) produktą (-us) ir programą (-as) be išankstinio įspėjimo.
2. Montavimo, techninės priežiūros ir su tinklu susijusius paruošimo darbus gali atlikti tik kvalifikuoti darbuotojai, kurie:
 - turi licenciją ir (arba) atitinka valstybės ir vietos jurisdikcijos taisykles;
 - gerai išmano šį vadovą ir kitus susijusius dokumentus.
3. Prieš montuodami įrenginį atidžiai perskaitykite, visiškai supraskite ir griežtai laikykitės išsamų naudotojo vadovo ir kitų susijusių taisyklių nurodymų. „SolaX“ neatsako už jokiais pasekmes, atsiradusias dėl šiam dokumente ir naudotojo vadove nurodytų laikymo, transportavimo, montavimo ir naudojimo taisyklių nesilaikymo.
4. Montuodami prietaisą naudokite izoliuotus įrankius. Montuojant, prijungiant prie elektros tinklo ir atliekant techninę priežiūrą būtina dėvėti individualias apsaugos priemones.
5. Daugiau informacijos rasite „SolaX“ svetainėje www.solaxpower.com.

Užrašų aprašymai

| | | | |
|---|---|---|--|
|  | CE atitikties ženklas |  | TUV sertifikavimas |
|  | RCM atitikties ženklas |  | UKCA atitikties ženklas |
|  | Papildomas žemiminimo kontaktas |  | Atsargiai, karštas paviršius |
|  | Atsargiai, elektros smūgio pavojus |  | Atsargiai, pavojinga |
|  | Perskaitykite pridedamus dokumentus |  | Neišmeskite inverterio su buitinėmis atliekomis. |
|  | Nenaudokite šio inverterio, kol jis nebus atjungtas nuo elektros tinklo ir vietoje veikiančių fotovoltinės energijos gamybos tiekėjų. | | |
|  | Aukštos įtampos pavojus. 5 minutes po atjungimo nuo maitinimo šaltinių nelieskite įtampą turinčių dalių. | | |

**PAVOJUS!****Mirtinas elektros smūgio pavojus dėl inverterio**

- Inverterį naudokite tik tada, kai jis yra techniškai tvarkingas. Priešingu atveju gali išstikti elektros smūgis arba kiti gaisras.
- Jokiu būdu neatidarykite korpuso be „SolaX“ leidimo. Atidarymas be leidimo panaikins garantijos galiojimą ir sukels mirtiną pavojų arba rimtus sužalojimus dėl elektros smūgio.

**PAVOJUS!****Mirtinas elektros smūgio pavojus dėl fotovoltinės energijos**

- Saulės šviesoje fotovoltiniai moduliai generuoja aukštą nuolatinę įtampą. Dėl elektros smūgio gali išstikti mirtis arba galima patirti mirtinus sužalojimus.
- Niekada nelieskite fotovoltinio jungiamojo įrenginio teigiamo arba neigiamo poliaus. Taip pat draudžiama liesti juos abu vienu metu.
- Neįžeminkite fotovoltinių teigiamo arba neigiamo poliaus.
- Fotovoltinių skydų elektros instaliaciją gali įrengti tik kvalifikuoti darbuotojai.

**ĮSPĖJIMAS!****Personalo sužeidimo arba inverterio pažeidimo rizika**

- Naudodami nelieskite jokių kitų dalių, išskyrus nuolatinės srovės (DC) jungiklį ir skystųjų kristalų skydelį.
- Niekada neįjunkite ir neatjunkite kintamosios ir nuolatinės srovės jungčių, kai veikia inverteris.
- Išjunkite kintamosios (AC) ir nuolatinės srovės (DC) maitinimus ir atjunkite juos nuo inverterio; tuomet palaukite 5 minutes, kad įtampa visiškai nukristų, prieš atlikdami bet kokius techninės priežiūros darbus, valydami ar dirbdami su bet kokiomis prijungtomis grandinėmis.
- Įsitinkinkite, kad nuolatinės srovės (DC)ėjimo įtampa \leq už maksimalią inverterio nuolatinės srovės (DC)ėjimo įtampą. Viršįtampis gali sukelti nuolatinę žalą inverteriui; tokiu atveju garantija NĖRA taikoma.

**DĖMESIO!**

- Neleiskite vaikams būti prie inverterio.
- Atkreipkite dėmesį į inverterio svorį. Netinkamai elgiantis gali būti sužaloti žmonės.

PASTABA!







- Jei pagal vietines taisykles reikalaujama naudoti išorinę srovės nuotėkio relę (RCD), patikrinkite, kokio tipo srovės nuotėkio relę reikalaujama pagal atitinkamas elektros taisykles. Rekomenduojama naudoti A tipo srovės nuotėkio relę, kurios vardinė srovė yra 300 mA.
- Visi ant inverterio esantys produkto užrašai ir vardinė lentelė turi būti gerai matomi.

Drošība

Vispārīgs paziņojums

1. Saturs periodiski var tikt atjaunots vai pārskatīts. SolaX patur tiesības bez iepriekšēja brīdinājuma veikt šajā rokasgrāmatā aprakstītā(-o) izstrādājuma(-u) un programmas(-u) uzlabojumus un izmaiņas.
2. Uzstādīšanu, apkopi un ar tīklu saistītos iestatījumus var veikt tikai kvalificēts personāls, kas atbilst šādām prasībām:
 - ir licencēts un/vai atbilst valsts un vietējo tiesību aktu noteikumiem;
 - labi pārzina šo rokasgrāmatu un citus saistītos dokumentus.
3. Pirms ierīces uzstādīšanas rūpīgi izlasiet, pilnīgi izprotiet un stingri ievērojiet lietotāja rokasgrāmatā un citos saistītajos noteikumos sniegtos norādījumus. SolaX neuzņemas atbildību ne par kādām sekām, ko izraisījuši šajā dokumentā un lietotāja rokasgrāmatā noteikto glabāšanas, transportēšanas, uzstādīšanas un ekspluatācijas noteikumu pārkāpumi.
4. Uzstādot šo ierīci, izmantojiet izolētus darbarīkus. Uzstādot, pievienojot elektrībai un veicot apkopi, jāvalkā individuālie aizsarglīdzekļi.
5. Lūdzu, apmeklējiet SolaX tīmekļa vietni www.solaxpower.com, lai saņemtu sīkāku informāciju.

Etīķešu apraksts

| | | | |
|---|---|---|--|
|  | CE atbilstības zīme |  | TUV sertifikācija |
|  | RCM atbilstības zīme |  | UKCA atbilstības zīme |
|  | Papildu zemējuma punkts |  | Uzmanību, karsta virsma |
|  | Uzmanību, elektriskās strāvas trieciena risks |  | Uzmanību, bīstamības risks |
|  | Izlasiet pievienotos dokumentus |  | Neizmetiet invertoru kopā ar sadzīves atkritumiem. |
|  | Neizmantojiet šo invertoru, ja tas nav izolēts no elektrotīkla un vietējiem saules paneļu generatoriem. | | |
|  | Augsta sprieguma radīts apdraudējums. Nepieskarieties strāvu vadošajām daļām 5 minūtes pēc atvienošanas no strāvas avotiem. | | |

⚠ BĪSTAMI!**Bojāejas risks invertora radīta elektriskās strāvas trieciena dēļ.**

- Eksploatējiet invertoru tikai tad, ja tam nav nekādu tehnisku defektu. Pretējā gadījumā var notikt elektriskās strāvas trieciens.
- Nekādā gadījumā neatveriet korpusu bez SolaX atļaujas. Neatļauta atvēršana anulē garantiju un rada bojāejas vai smagu traumu risku elektriskās strāvas trieciena dēļ.

⚠ BĪSTAMI!**Bojāejas risks saules paneļa radīta elektriskās strāvas trieciena dēļ.**

- Saules paneļu moduļi ģenerē lielu līdzstrāvas spriegumu, kad uz tiem iedarbojas saules gaismā. Elektriskās strāvas trieciens var izraisīt nāvi vai nāvējošus ievainojumus.
- Nekādā gadījumā nepieskarieties saules paneļu savienojuma ierīces pozitīvajam vai negatīvajam polam. Aizliegts ir arī pieskarties abiem poliem vienlaikus.
- Neiezemējiet saules paneļu moduļu pozitīvo vai negatīvo polu.
- Saules paneļu elektroinstalāciju drīkst veikt tikai kvalificēts personāls.

⚠ BRĪDINĀJUMS!**Fizisku ievainojumu vai invertora bojājuma risks**

- Eksploatācijas laikā nepieskarieties nekādām citām invertora daļām, izņemot līdzstrāvas slēdzi un LCD paneli.
- Nekad nepievienojiet un neatvienojiet maiņstrāvas un līdzstrāvas kontaktus, kad invertors darbojas.
- Pirms jebkādu apkopes vai tīrīšanas darbu veikšanas vai arī darba pie jebkuriem pieslēgtajiem kontūriem izslēdziet maiņstrāvas un līdzstrāvas barošanu, atvienojiet to no invertora un pēc tam nogaidiet 5 minūtes, lai spriegums pilnībā izlādētos.
- Pārliecinieties, ka ieejas līdzstrāvas spriegums ir mazāks par vai vienāds ar invertora maksimālo ieejas spriegumu. Pārspriegums var izraisīt neatgriezeniskus invertora bojājumus, ko NESEDZ garantija.

⚠ UZMANĪBU!

- Sargājiet invertoru no bērniem.
- Pievērsiet uzmanību invertora svaram. Rīkojoties neuzmanīgi, var gūt traumas.

IEVĒROJIET!













- Ja vietējie noteikumi paredz, ka nepieciešama paliekošās strāvas aizsargierīce (RCD), pārbaudiet, kāda veida RCD ierīce nepieciešama attiecīgajiem elektriskajiem kodiem. Ieteicams izmantot A tipa aizsargierīci ar 300 mA nominālu.
- Visām izstrādājuma etiķetēm un nosaukuma plāksnītei uz invertora jābūt skaidri salasāmām.

Bezpečnosť

Všeobecné upozornenia

1. Obsah dokumentu môže byť pravidelne aktualizovaný alebo revidovaný. Spoločnosť SolaX si vyhradzuje právo na akékoľvek zlepšenia a zmeny produktu (produktov) a programu (programov) popísaných v tomto návode bez predchádzajúceho upozornenia.
2. Inštaláciu, údržbu a nastavenie súvisiace so sieťou môže vykonávať len kvalifikovaný personál, ktorý:
 - má licenciu a/alebo spĺňa štátne a miestne právne predpisy,
 - je podrobne oboznámený s týmto návodom a ďalšími súvisiacimi dokumentmi.
3. Pred inštaláciou zariadenia si pozorne prečítajte, plne pochopíte a striktné dodržiavajte podrobné pokyny v návode na obsluhu a ďalšie súvisiace predpisy. Spoločnosť SolaX nezodpovedá za žiadne následky spôsobené porušením predpisov týkajúcich sa skladovania, prepravy, inštalácie a prevádzky, ktoré sú uvedené v tomto dokumente a návode na obsluhu.
4. Pri inštalácii zariadenia používajte izolované nástroje. Pri inštalácii, elektrickom zapojení a údržbe je nutné používať osobné ochranné pomôcky.
5. Viac informácií nájdete na webovej stránke spoločnosti SolaX www.solaxpower.com.

Popis štítkov

| | | | |
|---|---|---|---|
|  | CE označenie zhody |  | TUV certifikácia |
|  | RCM označenie zhody |  | UKCA označenie zhody |
|  | Dodatkový uzemňovací bod |  | Pozor, horúci povrch |
|  | Pozor, nebezpečenstvo úrazu elektrickým prúdom |  | Pozor, riziko nebezpečenstva |
|  | Prečítajte si priložené dokumenty |  | Nelikvidujte inverter spolu s komunálnym odpadom. |
|  | Nepracujte na tomto invertore, kým nie je odpojený od hlavnej rozvodnej siete a lokálnych modulov na výrobu fotovoltaickej energie. | | |
|  | Nebezpečenstvo vysokého napätia. Nedotýkajte sa častí pod napätím po dobu 5 minút po odpojení od zdroja napájania. | | |

NEBEZPEČENSTVO!

Smrteľné nebezpečenstvo úrazu elektrickým prúdom spôsobené invertorom

- Invertor uvádzajte do prevádzky len vtedy, ak je technicky bezchybný. V opačnom prípade môže dôjsť k úrazu elektrickým prúdom alebo požiaru.
- V žiadnom prípade neotvárajte kryt bez povolenia od spoločnosti SolaX. Neoprávnené otvorenie bude mať za následok stratu záruky a spôsobí smrteľné nebezpečenstvo alebo vážne zranenie v dôsledku úrazu elektrickým prúdom.

NEBEZPEČENSTVO!

Smrteľné nebezpečenstvo úrazu elektrickým prúdom spôsobené fotovoltikou

- Pri vystavení slnečnému žiareniu budú fotovoltické moduly generovať vysoké jednosmerné napätie. V dôsledku zásahu elektrickým prúdom môže dôjsť k usmrteniu alebo smrteľnému zraneniu.
- Nikdy sa nedotýkajte kladného alebo záporného pólu fotovoltického spojovacieho zariadenia. Dotýkať sa oboch naraz je tiež zakázané.
- Neuzeďmňujte kladný ani záporný pól fotovoltických modulov.
- Zapojenie fotovoltických panelov môže vykonávať len kvalifikovaný personál.

VAROVANIE!

Nebezpečenstvo poranenia osôb alebo poškodenia invertora

- Počas prevádzky sa nedotýkajte žiadnych častí okrem spínača jednosmerneho prúdu a LCD panela.
- Keď je invertor v prevádzke, nikdy nepripájajte ani neodpájajte konektory jednosmerneho a striedavého prúdu.
- Vypnite napájanie striedavým a jednosmerným prúdom a odpojte od nich invertor. Predtým, než pristúpíte k údržbe, čisteniu alebo práci na akýchkoľvek pripojených obvodoch, počkajte 5 minút, kým sa napätie úplne vybije.
- Uistite sa, že vstupné jednosmerné napätie \leq maximálne jednosmerné vstupné napätie invertora. Prepätie môže spôsobiť trvalé poškodenie invertora, na ktoré sa NEVZŤAHUJE záruka.

POZOR!

- Uchovávajte invertor mimo dosahu detí.
- Venujte pozornosť hmotnosti invertora. Pri nesprávnom zaobchádzaní môže dôjsť k zraneniu osôb.













UPOZORNENIE!

- Ak miestne predpisy vyžadujú inštaláciu externého prúdového chrániča, overte, ktorý typ prúdového chrániča sa vyžaduje pre príslušné elektrické kódy. Odporúča sa použiť prúdový chránič typu A s citlivosťou 300 mA.
- Všetky produktové štítky a typový štítok na invertore musia byť udržiavané tak, aby boli dobre viditeľné.

Splošno obvestilo

1. Vsebina se lahko občasno posodablja ali revidira. SolaX si pridržuje pravico do izboljšav ali sprememb v izdelkih in programih, opisanih v tem priročniku, brez predhodnega obvestila.
2. Namestitev, vzdrževanje in nastavitve, povezano z omrežjem, lahko izvaja samo usposobljeno osebe, ki:
 - ima licenco in/ali izpolnjuje državne in lokalne predpise;
 - dobro pozna ta priročnik in druge povezane dokumente.
3. Pred namestitvijo naprave natančno preberite, v celoti razumite in dosledno upoštevajte podrobna navodila uporabniškega priročnika in druge s tem povezane predpise. SolaX ne prevzema odgovornosti za posledice, ki nastanejo zaradi kršitve predpisov o shranjevanju, transportu, namestitvi in delovanju, navedenih v tem dokumentu in uporabniškem priročniku.
4. Pri nameščanju naprave uporabljajte izolirana orodja. Med namestitvijo, električnim priklopom in vzdrževanjem je treba nositi osebna zaščitna orodja.
5. Za več informacij obiščite spletno stran www.solaxpower.com podjetja SolaX.

Opisi nalepk

| | | | |
|---|---|---|---|
|  | Oznaka skladnosti CE |  | TUV certifikat |
|  | Oznaka skladnosti RCM |  | Oznaka skladnosti UKCA |
|  | Dodatna ozemljitvena točka |  | Pozor, vroča površina |
|  | Pozor, nevarnost električnega udara |  | Pozor, možna nevarnost |
|  | Preberite priloženo dokumentacijo |  | Razsmernika ne odlagajte skupaj z gospodinjskimi odpadki. |
|  | Ne uporabljajte tega razsmernika, dokler ni izoliran od električnega omrežja in dobaviteljev fotonapetostne proizvodnje na kraju samem. | | |
|  | Nevarnost visoke napetosti. Ne dotikajte se delov pod napetostjo 5 minut po odklopu iz virov napajanja. | | |

NEVARNOST!

Smrtna nevarnost zaradi električnega udara zaradi razsmernika

- Razsmernik uporabljajte le, če je tehnično brezhiben. V nasprotnem primeru lahko pride do električnega udara ali požara.
- V nobenem primeru ne odpirajte ohišja brez dovoljenja družbe SolaX. Nepooblaščen odpiranje bo razveljavilo garancijo in povzročilo smrtno nevarnost ali resne poškodbe zaradi električnega udara.

NEVARNOST!

Smrtna nevarnost zaradi električnega udara zaradi fotonapetosti

- Ko so izpostavljeni sončni svetlobi, bodo fotonapetostni moduli ustvarili visoko enosmerno napetost. Zaradi električnega udara lahko pride do smrti ali smrtnih poškodb.
- Nikoli se ne dotikajte pozitivnega ali negativnega pola fotonapetostne priključne naprave. Prepovedano je tudi dotikanje obeh hkrati.
- Ne ozemljite pozitivnega ali negativnega pola fotonapetostnih modulov.
- Ožičenje fotonapetostnih panelov lahko izvaja samo usposobljeno osebje.

OPOZORILO!

Nevarnost telesnih poškodb ali poškodb razsmernika

- Med delovanjem se ne dotikajte nobenih delov razen stikala DC, LCD plošče.
- Nikoli ne priklaplajte ali odklapljajte priključkov AC in DC, ko razsmernik deluje.
- Izklopite napajanje izmeničnega in enosmernega toka in ju odklopite iz razsmernika, počakajte 5 minut, da se napetost popolnoma izprazni, preden poskusite vzdrževati, čistiti ali delati na katerem koli priključenem tokokrogu.
- Prepričajte se, da je vhodna enosmerna napetost \leq največja enosmerna vhodna napetost razsmernika. Previsoka napetost lahko povzroči trajno škodo na razsmerniku, česar garancija NE pokriva.

POZOR!

- Otroci naj se ne približujejo razsmerniku.
- Bodite pozorni na težo razsmernika. Če z njim ne ravnate pravilno, lahko pride do telesnih poškodb.

OBVESTILO!

- Če lokalni predpisi zahtevajo zunanji RCD, preverite, kateri tip RCD je zahtevan za ustrezne električne kode. Priporočljivo je, da uporabite RCD tipa A z vrednostjo 300 mA.
- Vse oznake izdelkov in tablica z imenom na pretvorniku morajo biti jasno vidni na razsmerniku.













Güvenlik

Genel Bildirim

1. İçindekiler periyodik olarak güncellenebilir veya revize edilebilir. SolaX, önceden haber vermeksizin ürün(ler) ve bu kılavuzda açıklanan program(lar) üzerinde iyileştirme veya değişiklik yapma hakkını saklı tutar.
2. Kurulum, bakım ve şebekeyle ilgili ayar sadece aşağıdaki özelliklere sahip kalifiye personel tarafından gerçekleştirilebilir:
 - Ulusal ve yerel yasal yetki bölgelerinde lisanslı olmalı ve buralardaki düzenlemelerde uyumlu olmalıdır;
 - Bu kılavuz ve diğer ilgili dokümanlar hakkında iyi bilgiye sahip olmalıdır.
3. Cihazı kurmadan önce kullanım kılavuzunun ve diğer ilgili düzenlemelerin ayrıntılı talimatlarını dikkatlice okuyun, tam olarak anlayın ve kesinlikle uygulayın. SolaX, bu dokümanda ve kullanım kılavuzunda belirtilen depolama, taşıma, kurulum ve işletme düzenlemelerinin ihlalinin kaynaklanan sonuçlardan sorumlu olmayacaktır.
4. Cihazı kurarken yalıtımlı aletler kullanın. Kurulum, elektrik bağlantısı ve bakım sırasında bireysel koruyucu aletler takılmalıdır.
5. Daha fazla bilgi için lütfen www.solaxpower.com of SolaX web sitesini ziyaret edin.

TÜRKÇE

Etiketlerin Açıklamaları

| | | | |
|---|---|---|---|
|  | CE uygunluk işareti |  | TUV uygunluk işareti |
|  | RCM uygunluk işareti |  | UKCA uygunluk işareti |
|  | ETL uygunluk işareti |  | Dikkat, sıcak yüzey |
|  | Dikkat, elektrik çarpması riski |  | Dikkat, tehlike riski |
|  | Ekteki dokümanları okuyun |  | Invertörü evsel atıklarla birlikte atmayın. |
|  | Ek topraklama noktası | | |
|  | Şebeke ve yerinde PV üretimi besleyicilerinden izole edilene kadar bu invertörü çalıştırmayın. | | |
|  | Yüksek gerilim tehlikesi. Güç kaynaklarından ayrıldıktan sonra yükü parçalara 5 dakika boyunca dokunmayın. | | |

⚠ TEHLİKE!

İnvertör nedeniyle elektrik çarpması kaynaklı ölümcül tehlike

- İnvertörü yalnızca teknik olarak hatasız olduğunda çalıştırın. Aksi takdirde elektrik çarpması veya yangın meydana gelebilir.
- Muhafazayı hiçbir durumda SolaX'in izni olmadan açmayın. Yetkisiz açılma garantiyi geçersiz kılar ve elektrik çarpması nedeniyle ölümcül tehlikeye veya ciddi yaralanmalara neden olur.

⚠ TEHLİKE!

PV nedeniyle elektrik çarpması kaynaklı ölümcül tehlike

- Güneş ışığına maruz kaldığında PV modülleri tarafından yüksek DC gerilim üretilmektedir. Elektrik çarpması nedeniyle ölüm veya ölümcül yaralanmalar meydana gelecektir.
- PV bağlantı cihazının pozitif veya negatif kutbuna asla dokunmayın. İkisine de aynı anda dokunmak da yasaktır.
- PV modüllerinin pozitif veya negatif kutbunu topraklamayın.
- PV panellerinin kablolarını yalnızca kalifiye personel bağlayabilir.

⚠ UYARI!

Personel yaralanması veya invertör hasarı riski

- Çalışma sırasında DC anahtarı ve LCD panel dışındaki herhangi bir parçaya dokunmayın.
- İnvertör çalışırken AC ve DC konektörlerini asla bağlamayın veya çıkarmayın.
- AC ve DC gücü kapatın ve invertörden ayırın, bağlı devrelerde herhangi bir bakım, temizlik veya çalışma yapmadan önce gerilimin tamamen boşalması için 5 dakika bekleyin.
- Giriş DC geriliminin invertörün maksimum DC giriş geriliminden az veya buna eşit olduğundan emin olun. Aşırı gerilim invertörde garanti kapsamına girmeyen kalıcı hasara neden olabilir.

⚠ DİKKAT!

- Çocukları invertörden uzak tutun.
- İnvertörün ağırlığına dikkat edin. Doğru şekilde kullanılmazsa kişisel yaralanmalara neden olabilir.

BİLDİRİ!

- Yerel düzenlemeler tarafından harici bir RCD gerekiyorsa ilgili elektrik kodları için hangi tür RCD'nin gerekli olduğunu kontrol edin. 300 mA değerinde bir Tip A RCD kullanılması önerilir.
- İnvertördeki tüm ürün etiketleri ve isim plakası açıkça görülebilir.













Segurança

Aviso Geral

1. Os conteúdos podem ser periodicamente atualizados ou revistos. A SolaX se reserva o direito de efetuar melhorias ou mudanças no(s) produto(s) e no(s) programa(s) descrito(s) neste manual sem aviso prévio.
2. A instalação, a manutenção e a configuração relativa à rede apenas podem ser realizadas por pessoal qualificado que:
 - É licenciado e/ou satisfaz aos regulamentos das jurisdições estaduais e locais;
 - Tem bons conhecimentos sobre este manual e outros documentos relacionados.
3. Antes da instalação do dispositivo, leia cuidadosamente, entenda totalmente e siga rigorosamente as instruções detalhadas do manual do usuário e de outros regulamentos relevantes. A SolaX será responsável por quaisquer consequências causadas pela violação dos regulamentos de armazenamento, transporte, instalação e regulamentos de operação especificados neste documento e no manual do usuário.
4. Utilize as ferramentas isoladas ao instalar o dispositivo. As ferramentas de proteção individuais devem ser usadas durante a instalação, a conexão elétrica e a manutenção.
5. Por favor visite o site eletrônico www.solaxpower.com da SolaX para mais detalhes.

PORTUGUÊS
(BRASILEIRO)

Descrições dos Rótulos

| | | | |
|---|--|---|---|
|  | Marca CE de conformidade |  | Certificação TUV |
|  | Marca RCM de conformidade |  | Marca UKCA de conformidade |
|  | Certificação ETL |  | Atenção, superfície quente |
|  | Atenção, risco de choque elétrico |  | Atenção, risco de perigo |
|  | Leia as documentações em anexo |  | Não descarte o inversor juntamente com resíduos domésticos. |
|  | Ponto de aterramento adicional | | |
|  | Não opere esse inversor até que ele esteja isolado da rede elétrica e dos fornecedores de geração fotovoltaica no local. | | |
|  | Perigo de alta tensão. Não toque em partes vivas por 5 minutos após a desconexão da fonte de alimentação. | | |

PERIGO!

Perigo de morte por choque elétrico devido ao inversor

- Somente opere o inversor quando ele não estiver tecnicamente defeituoso. Caso contrário, pode ocorrer choque elétrico ou incêndio.
- Não abra o invólucro em qualquer caso sem autorização da SolaX. A abertura não autorizada violará a garantia e causará perigo de morte ou ferimentos graves devido ao choque elétrico.

PERIGO!

Perigo de morte de choque elétrico devido à FV

- Quando exposto à luz solar, a alta tensão CC será gerada pelos módulos FV. Ocorrerá morte ou lesões graves devido a choque elétrico.
- Nunca toque no pólo positivo ou negativo do dispositivo de conexão FV. Também é proibido tocar em ambos ao mesmo tempo.
- Não aterre o pólo positivo ou negativo dos módulos FV.
- Somente pessoal qualificado pode realizar a cablagem dos painéis FV.

ADVERTÊNCIA!

Risco de ferimentos pessoais ou danos ao inversor

- Durante a operação, não toque em nenhuma parte que não seja o interruptor CC e o painel LCD.
- Nunca ligue ou desligue os conectores CA e CC quando o inversor estiver funcionando.
- Desligue a energia CA e CC e desconecte-as do inversor, aguarde por 5 minutos para descarregar totalmente a tensão antes de tentar fazer qualquer manutenção, limpeza ou trabalho em qualquer circuito conectado.
- Certifique-se de que a tensão de entrada CC seja \leq a tensão de entrada CC máxima do inversor. A sobretensão pode causar dano permanente ao inversor, o que NÃO é coberto pela garantia.



ATENÇÃO!

- Mantenha-se a criança longe do inversor.
- Preste atenção ao peso do inversor. Os ferimentos pessoais podem ser causados se não forem tratados adequadamente.

AVISO!

- Se um RCD externo for necessário pelos regulamentos locais, verifique em que tipo de RCD é exigido pelos códigos elétricos relevantes. É recomendado usar um RCD do Tipo-A com o valor de 300mA.
- Todos os rótulos e placas de identificação do produto no inversor devem ser mantidos claramente visíveis.

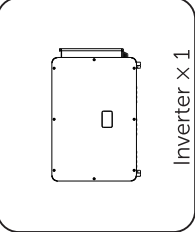
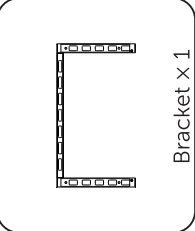
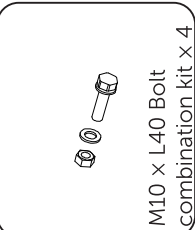

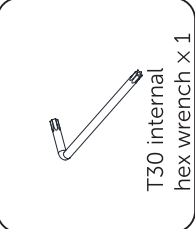
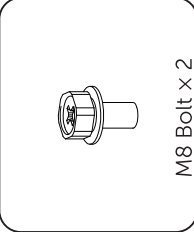
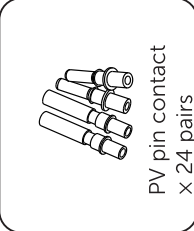
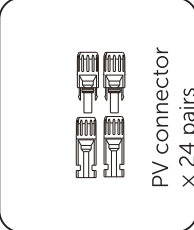
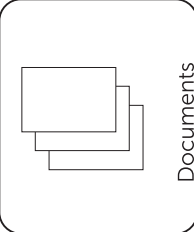
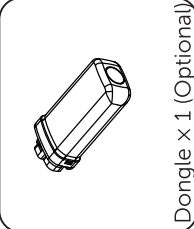
Packing List / Packliste / Liste du matériel livré / Lista de piezas / Lista da embalagem / Paklijst / Contenido della confezione / Zawartość opakowania / Seznam balení / Packlista / Lista de ambalare / Οπακωvχεν λιστ / Pakkeliste / Λίστα συσκευασίας / Pakkeleht / Pakkausluettelo / Popis pakiranja / Csomaglista / Pakuotės turinys / Iepakoјuma saraksts / Zoznam položiek balenia / Seznam pakiranja / Kutu Listesii / Lista de Embalagem

| | | | | |
|---|--|---|---|---|
|  |  |  |  |  |
| Inverter x 1 | Bracket x 1 | M10 x L40 Bolt combination kit x 4 | Communication connector x 1 | T30 internal hex wrench x 1 |
|  |  |  |  |  |
| M8 Bolt x 2 | PV pin contact x 24 pairs | PV connector x 24 pairs | Documents | Dongle x 1 (Optional) |

* **Note:** Refer to the actual delivery for the optional accessories.

PV pin contact and PV connector: 12 pairs for 40 kW and 50 kW inverter;
18 pairs for 60 kW to 110 kW inverter; 24 pairs for 120 kW to 150 kW inverter.
Please purchase OT terminals separately.

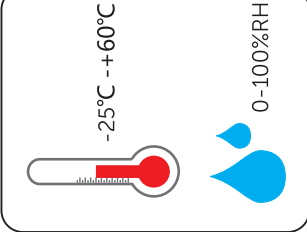
Installation Site / Installationsort / Site d'installation / Sitio de instalación / Local de instalação / Installatiesite / Sito di installazione / Miejsce instalacji / Místo instalace / Installationsplats / Loc de instalare / Монтажен объект / Monteringssted / Τόπος εγκατάστασης / Paigaldamise koht / Asennuspaikka / Lokacija ugradnje / Telepitési helyszín / Montavimo vieta / Uzstādīšanas vieta / Miesto instalácie / Mesto namestive / Kurulum Yeri / Local de Instalação

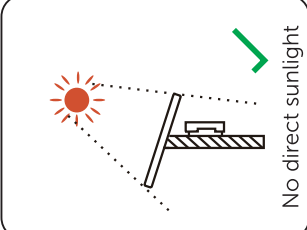
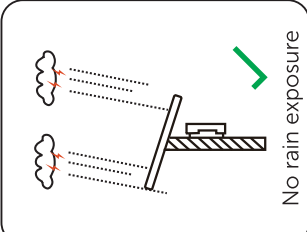
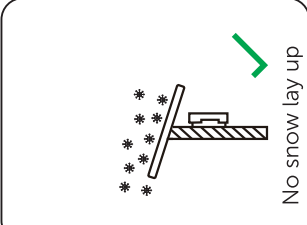
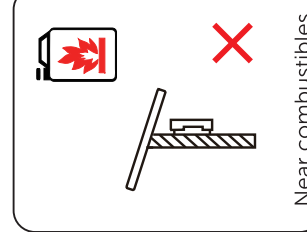
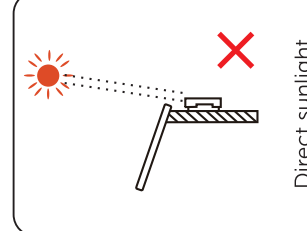
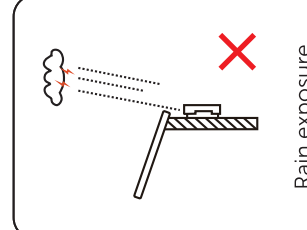
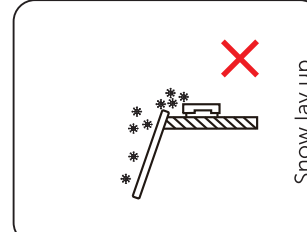
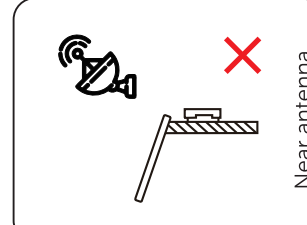
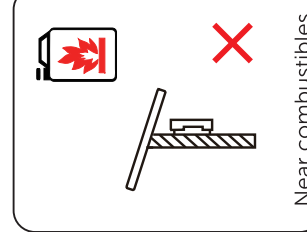
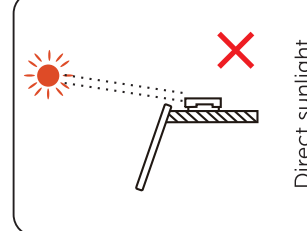
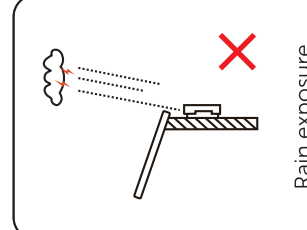
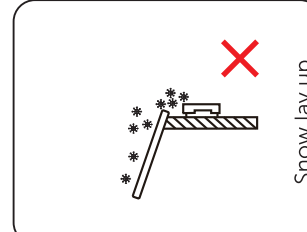
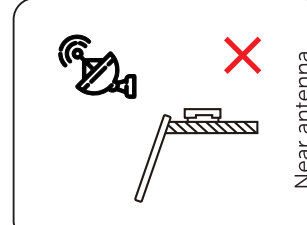
| | | | | |
|---|--|---|---|---|
|  |  |  |  |  |
| -25°C --+60°C | IP66 | No direct sunlight | No rain exposure | No snow lay up |
|  |  |  |  |  |
| 0-100%RH | Near combustibles | Direct sunlight | Rain exposure | Snow lay up |
|  |  |  |  |  |
| Near combustibles | Near antenna | Rain exposure | Snow lay up | Near antenna |

Installation Carrier / Installationsträger / Partie porteuse / Soporte de instalación /
 Suporte de Instalação / Installatiedrager / Supporto di installazione / Powierzchnia
 montażowa / Nosič instalace / Installationsfästen / Suport instalație / Монтажна
 основа / Monteringsholder / Μεταφορέας εγκατάστασης / Paigalduskandja /
 Asennusteline / Nosač za ugradnju / Telepitési szolgálató / Montavimo pagrindas /
 Instalācijas turētājs / Nosná konštrukcia pre inštaláciu / Namestitveni nosilec / Kurulum
 Taşıyıcı / Portador de Instalação

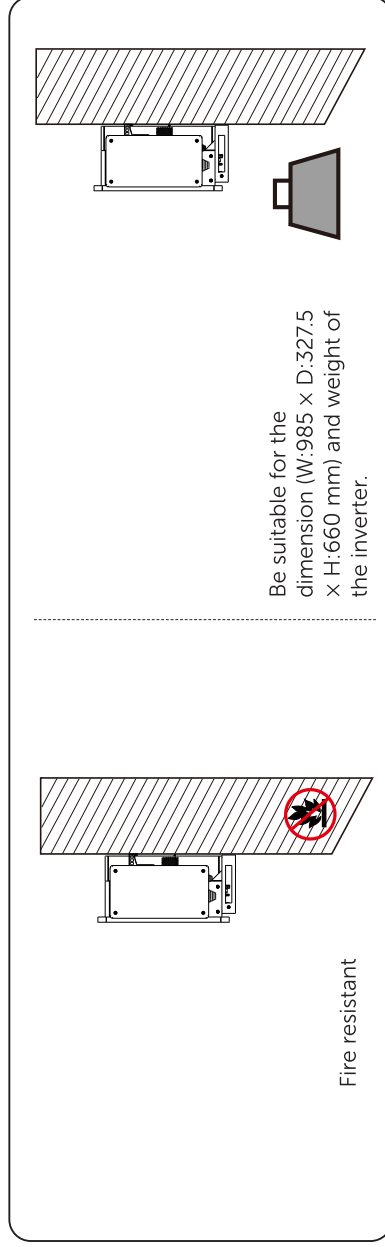

| | | | | | | | | | | | | |
|-------------|---------|-------|-------|-------|-------|-------|--------|--------|--------|--------|--------|--------|
| Inverter | 40 kW | 50 kW | 60 kW | 70 kW | 75 kW | 80 kW | 100 kW | 110 kW | 120 kW | 125 kW | 136 kW | 150 kW |
| Weight (kg) | 80.5 kg | | | | | | | | | | | 87 kg |

Installation Angle / Installationswinkel / Angle d'installation / Ângulo de instalação /
 Ângulo de instalação / Installatiehoek / Angolazione di installazione / Kaç instalacjii
 / Instalační úhel / Installationsvinkel / Unghi de instalare / Монтажен ъгъл /
 Monteringsvinkel / Γωνία εγκατάστασης / Paigaldusnurk / Asennuskulma / Kut
 ugradnje / Telepitési szög / Montavimo kampas / Uzstādīšanas leņķis / Uhol inštalácie /
 Namestitveni kot / Kurulum Açısı / Ângulo de Instalação

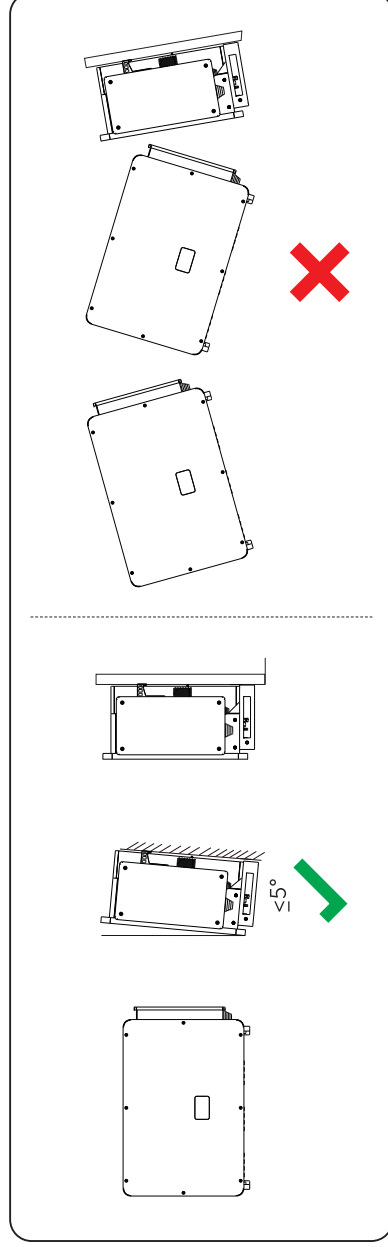

Installation Space / Installationsraum / Espace d'installation / Espacio de instalación / Espaço de instalação / Installierumimte / Spazio di installazione / Przestrzeń instalacyjna / Instalační prostor / Installationsutrymme / Spatiu de instalare / Монтажно пространство / Monteringsplads / Χώρος εγκατάστασης / Paigaldusruum / Asennustila / Mjesto ugradnje / Telepítési tér / Montavimo erdvė / Uzstādīšanas telpa / Priestor pre inštaláciu / Prostor za nameštitev / Kurulum Alanı / Espaço de Instalação

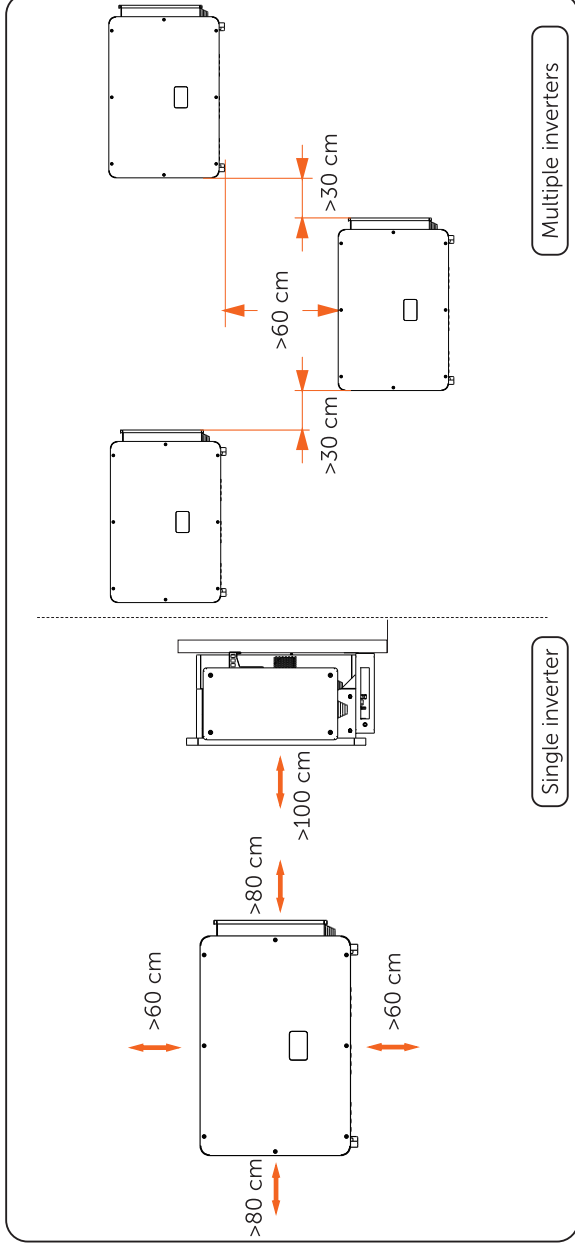

Installation Tools / Installationswerkzeuge / Outils d'installation / Herramientas de instalación / Ferramentas de instalação / Installatiemiddelen / Utensili di installazione / Narzędzia do instalacji / Instalační nástroje / Verktøy for installation / Instrumente de instalare / Монтажни инструменти / Monteringsværktøjer / Εργαλεία εγκατάστασης / Paigaldamise tööriistad / Asennustyökalut / Alati za ugradnju / Nástroje pre inštaláciu / Orodja za nameštitev / Kurulum Araçları / Ferramentas de Instalação

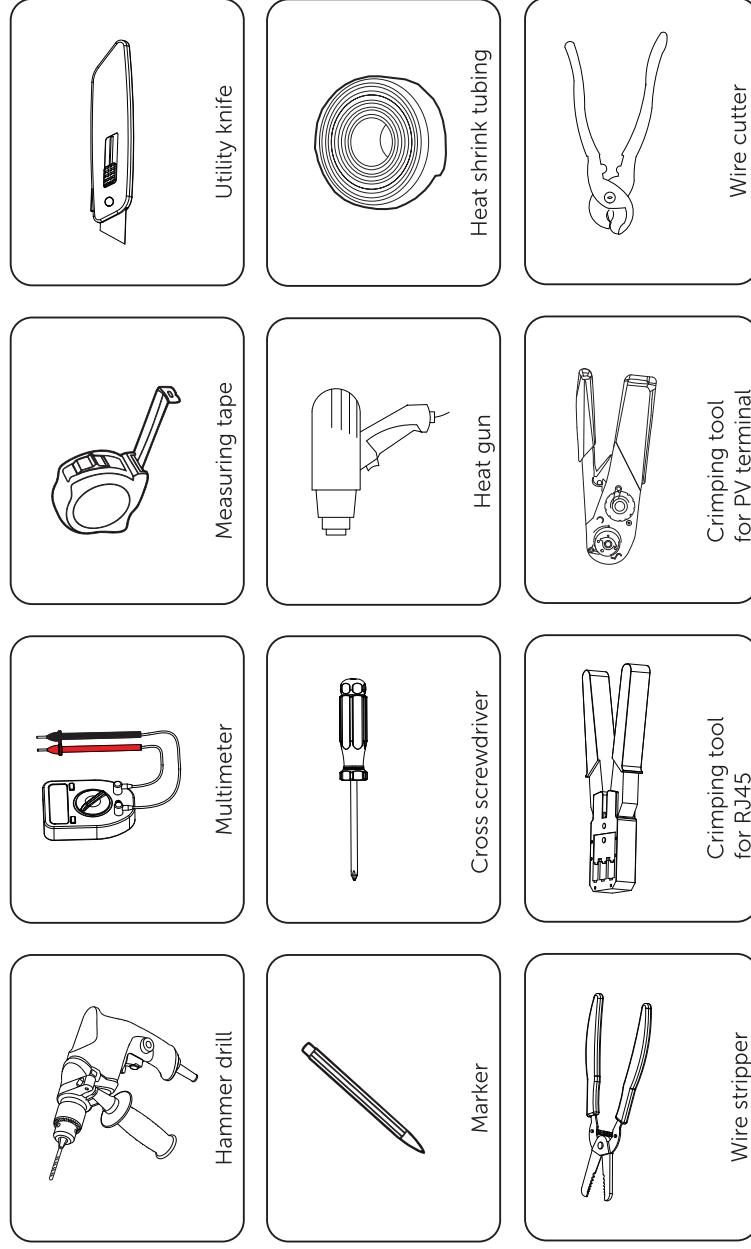

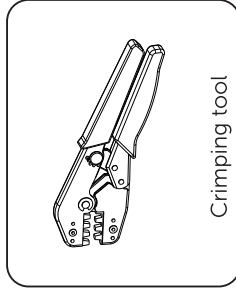

Crimping tool

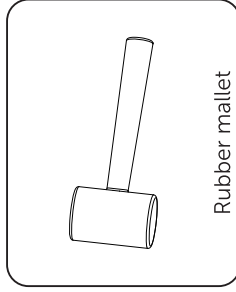

Rubber mallet

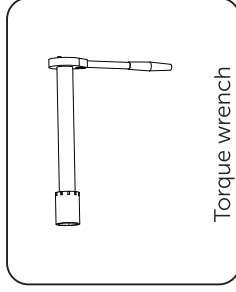

Torque wrench

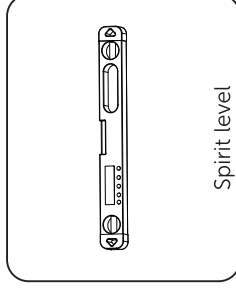

Spirit level

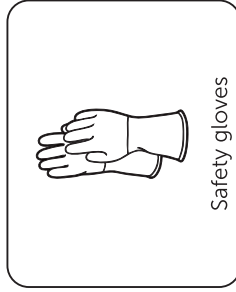

Safety gloves

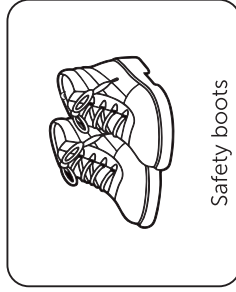

Safety boots

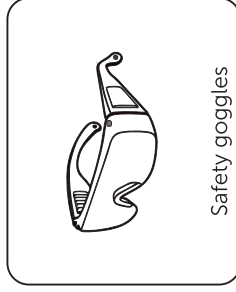

Safety goggles

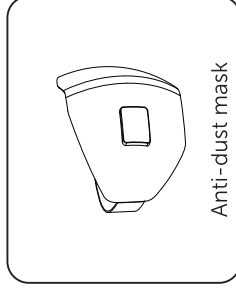

Anti-dust mask

Additionally Required Materials / Zusätzlich erforderliche Materialien / Matériaux supplémentaires requis / Materiales adicionales necesarios / Materiais Adicionais Necessários / Extra benodigde materialen / Materiali aggiuntivi necessari / Materiati wymagane dodatkowo / Další požadované materiály / Ytterligere materialkrav / Materiale supplimentare necesare / Други необхідими материали / Yderligere nødvendige materialer / Πρόσθετα απαιτούμενα υλικά / Täiendavad vajalikud materjalid / Muut vaaditud materiaalit / Potrebni dodatni materijali / További szükséges anyagok / Papildomos reikalingos medžiagos / Papildus vajadzīgie materiāli / Dodatčne požadované materiály / Dodatno zahtevani materiali / Ayrıca Gereklı Malzemeler / Materiais Adicionais Necessários

| No. | Required Material | Type | Conductor Cross-Section | Cable Length | | | | | | | | |
|------------|----------------------------------|---|---|--------------|-------|-------|--------|--------|--------|--------|--------|--------|
| 1 | PV cable | Dedicated PV wire complying with 1,500 V standard | 4-6 mm ² | ≤200 m | | | | | | | | |
| 2 | AC cable (40-125 kW) | Five-core copper wire | 70 mm ² -240 mm ² | ≤200 m | | | | | | | | |
| | | Five-core aluminium wire | 70 mm ² -240 mm ² | ≤200 m | | | | | | | | |
| 3 | AC cable (136-150 kW) | Four-core copper wire | 70 mm ² -240 mm ² | ≤200 m | | | | | | | | |
| | | Four-core aluminium wire | 70 mm ² -240 mm ² | ≤200 m | | | | | | | | |
| 4 | Communication cable | Network cable CAT5 or better | 0.5 mm ² -0.75 mm ² | ≤150 m | | | | | | | | |
| | | Communication terminal | ENY0512 nylon terminal for 0.5 mm ² / 22 AWG conductor ENY7512 nylon terminal for 0.75 mm ² / 20 AWG conductor | | | | | | | | | |
| 5 | Additional PE cable | Conventional yellow and green wire | 35 mm ² -70 mm ² | ≤200 m | | | | | | | | |
| 6 | M10 x L80 expansion bolt kit x 4 | For wall-mounting | / | / | | | | | | | | |
| Inverter | 40 kW | 50 kW | 60 kW | 70 kW | 75 kW | 80 kW | 100 kW | 110 kW | 120 kW | 125 kW | 136 kW | 150 kW |
| AC breaker | 150 A | 200 A | 250 A | 250 A | 250 A | 150 A | 200 A | 200 A | 250 A | 250 A | 200 A | 250 A |

Mechanical Installation / Mechanische Installation / Installazione meccanica / Instalación mecánica / Instalação mecânica / Mechanische installatie / Installazione meccanica / Instalacja mechaniczna / Mechanická instalace / Mekanisk installation / Mecanisk installation / Μηχανική εγκατάσταση / Mehaaniline paigaldus / Mekaaninen asennus / Mehaanická ugradnja / Mechanikai telepítés / Mechaninis montavimas / Mehāniskā uzstādīšana / Mechanická inštalácia / Mehanska namestitvev / Mekanik Kurulum / Instalação Mecânica

- Stand-mounting

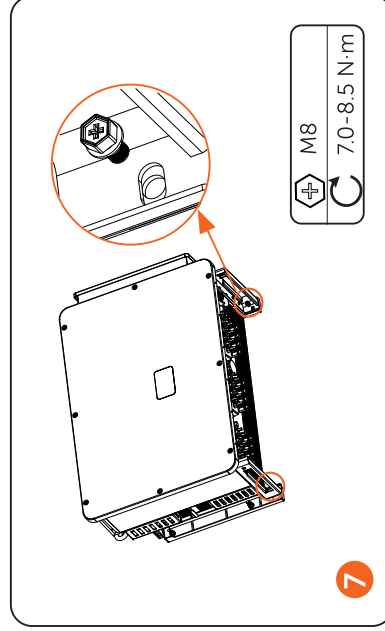
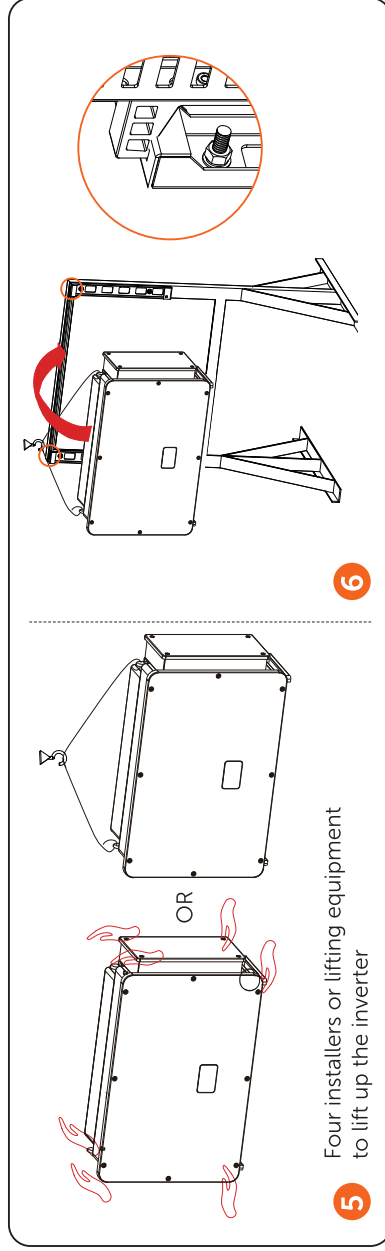
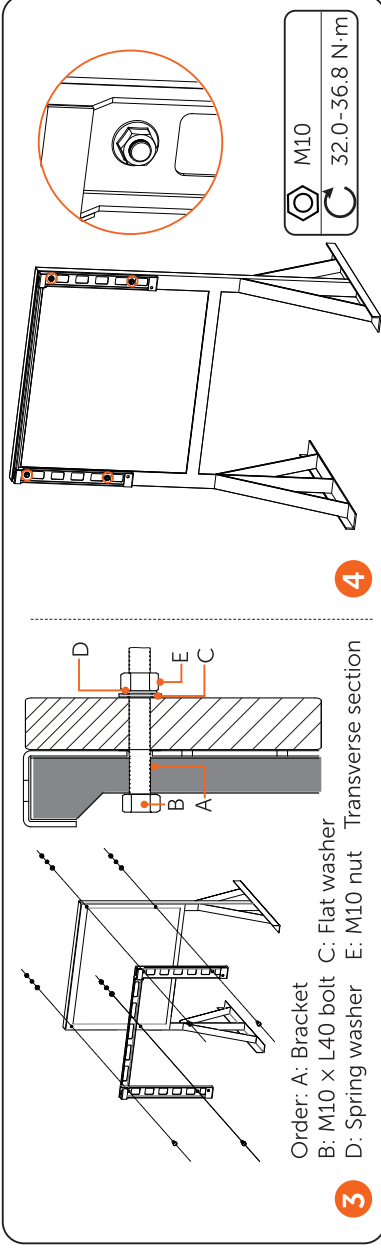
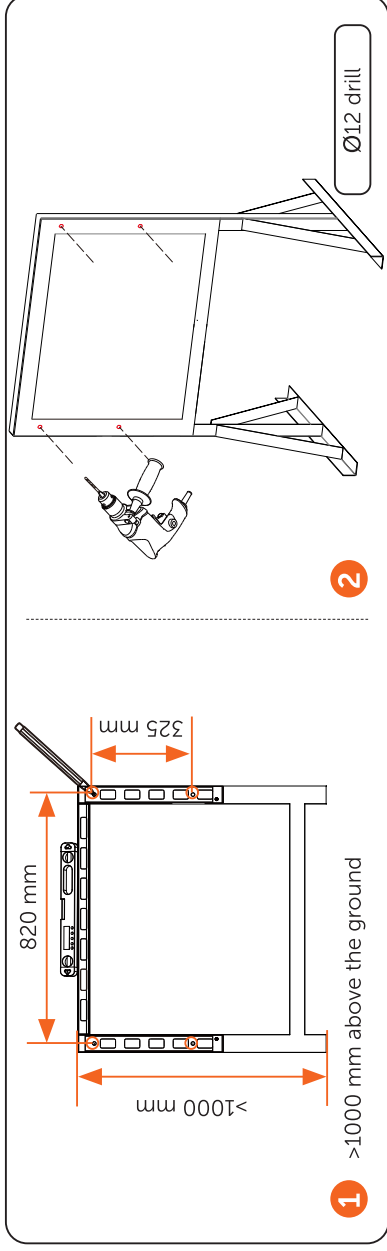

• Wall-mounting

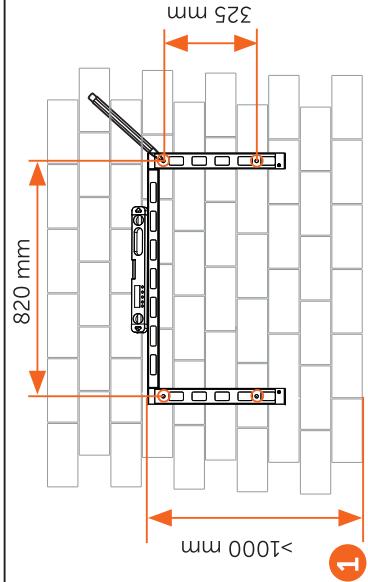

1

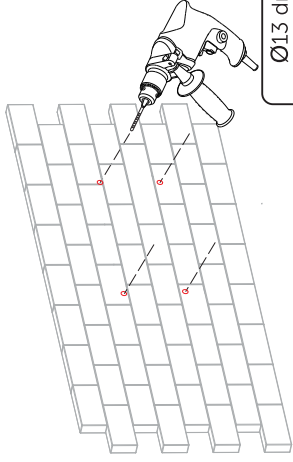

Ø13 drill

Depth: >65 mm

2

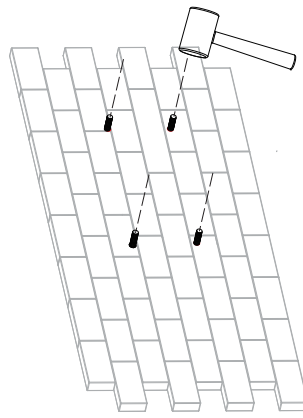

3 Prepare M10 x L80 expansion bolt kit by customer

4

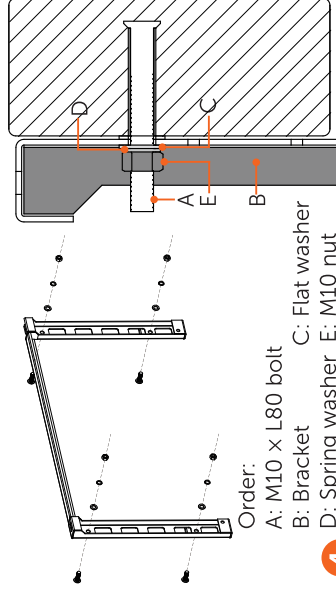

Transverse section

Order:
A: M10 x L80 bolt
B: Bracket
C: Flat washer
D: Spring washer
E: M10 nut

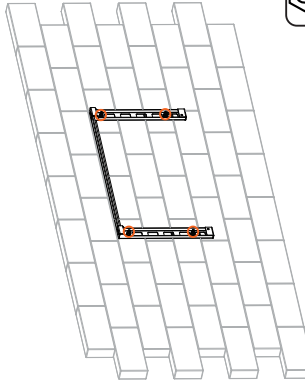

M10
32.0-36.8 N.m

5

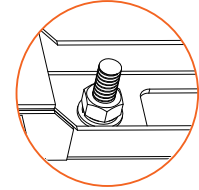

OR

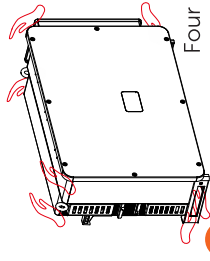

Four installers or lifting equipment
to lift up the inverter

6

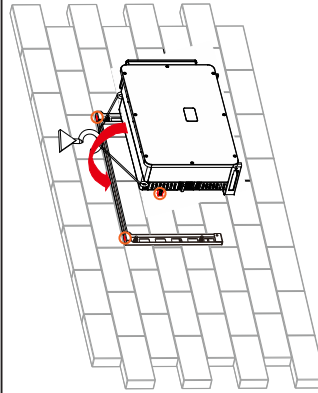
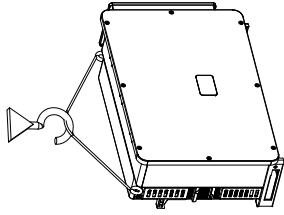

7

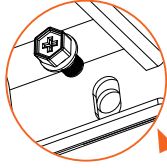
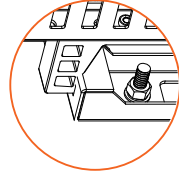

M8
7.0-8.5 N.m

8

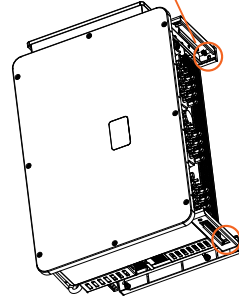

PE Connection / Schutzerdungs-Anschluss / Connexion PE / Conexión PE / Ligação à Terra / PE-aansluiting / Collegamento PE / Połączenie PE / PE připojení / PE-anslutning / Conexiune PE / PE връзка (земя) / Jordforbindelse / Σύνδεση PE / PE ühendus / PE-yhteys / PE priključak / PE bekötés / PE (apsauginio įžeminimo) kontaktas / PE savienojums / Pripojenie ochranného vodiča / PE povezava / PE Bağlantısı / Conexão PE

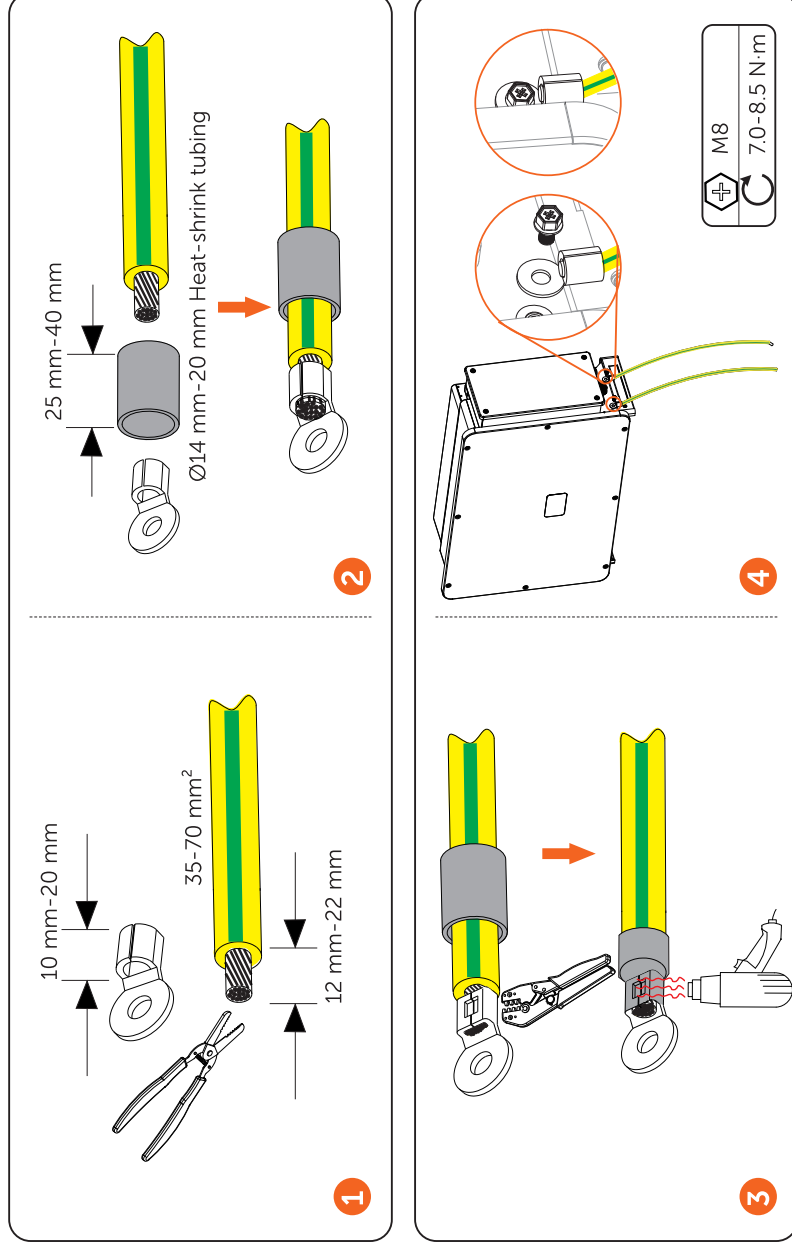

AC Side Connection / Wechselstrom-seitiger Anschluss / Connexion côté CA / Conexión lateral de CA / Ligação lateral CA / Aansluiting wisselspanningszijde / Collegamento lato CA / Połączenie po stronie AC / Војни припојени стрјдаваћо протуду / Anslutning på AC-sidan / Conexiune laterală c.a. / Σωρζρване от AC страната / AC-puolen sidetilislutning / Πλαϊνή σύνδεση AC / Vaheiduvoolpoolne ühendus / AC-puolen liitântä / Prikliučak za izmjeničnu struju (AC) / Váltóáram-oldali bekötés / AC (kint. sr.) šoninis kontaktas / Mainstrāvas puses savienojums / Pripojenie na strane striedavého prúdu / AC stranska povezava / AC Yan Bağlantı / Conexão do Lado CA

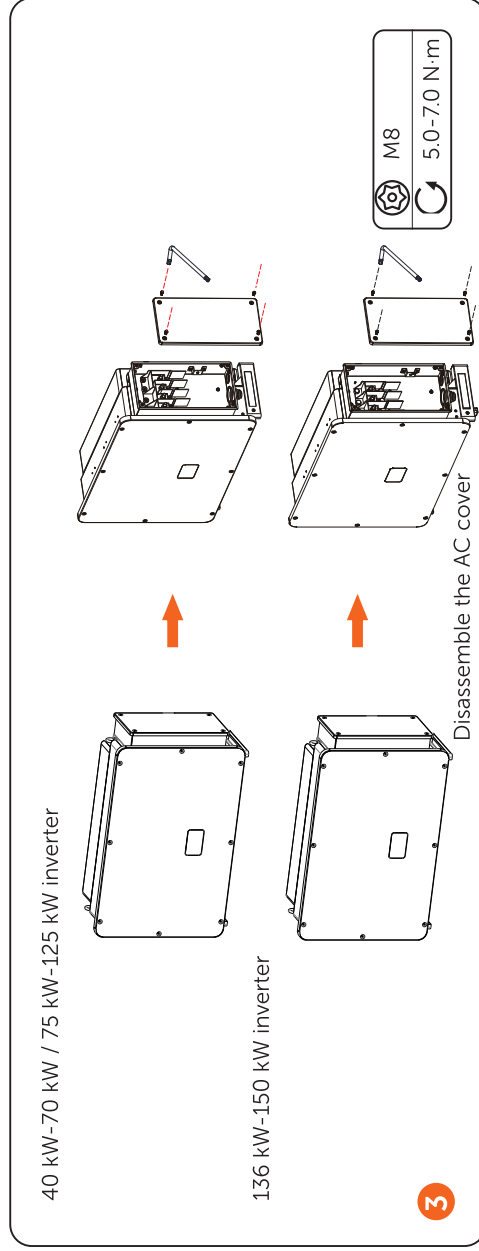
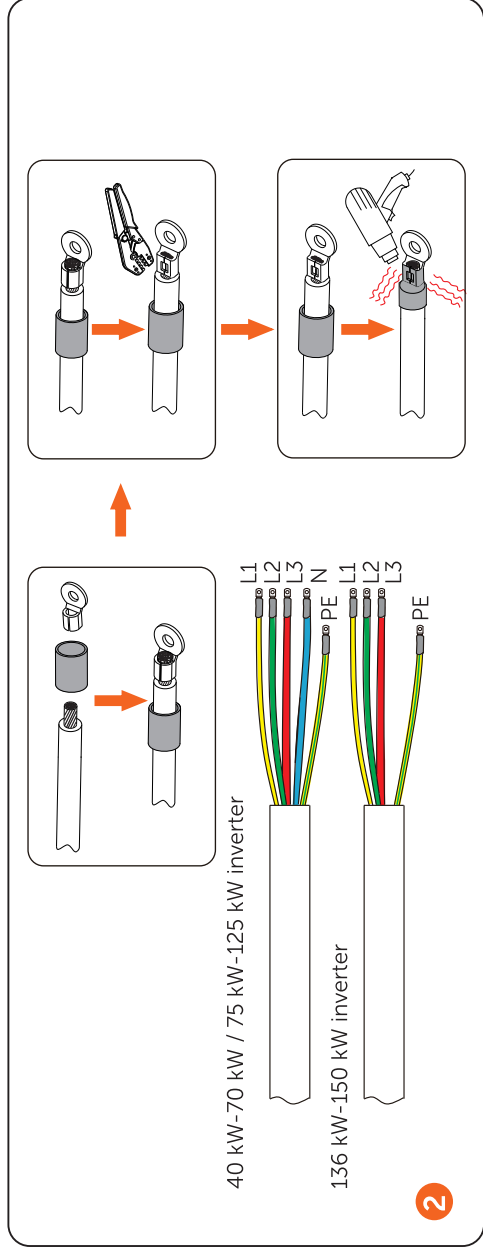
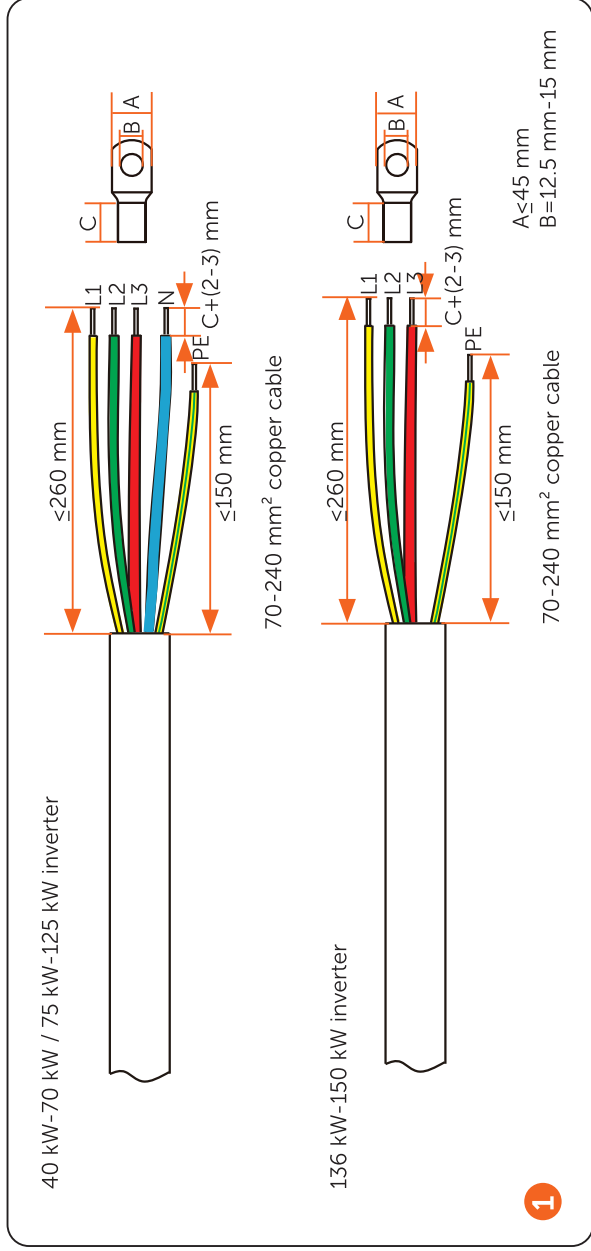

40 kW-70 kW / 75 kW-125 kW inverter for example

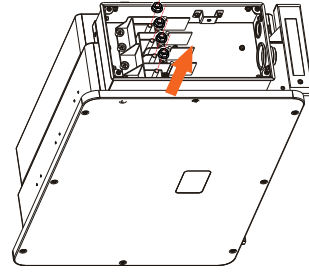
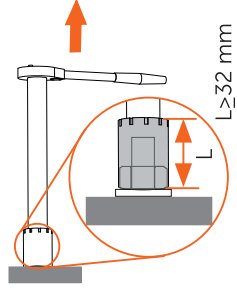
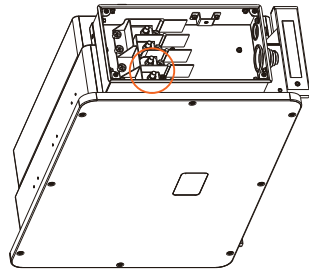

M12
25-30 N·m

4 Disassemble the M12 nut

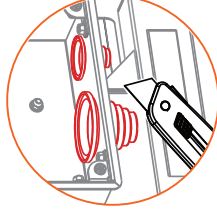

Cut off the tower shaped wiring grommet based on the actual cable size.

5

40 kW-70 kW / 75 kW-125 kW inverter for example

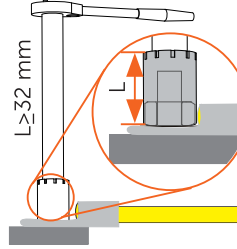
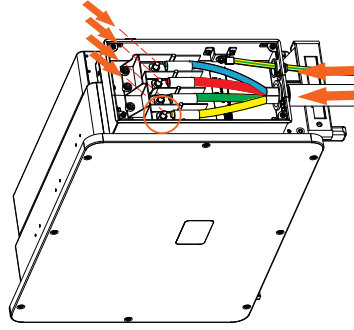

M12
25-30 N·m

6 Tighten PE cable before connecting L and N cable.

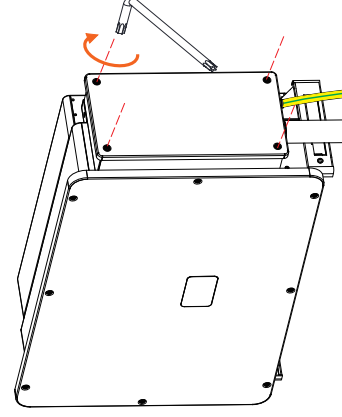

M8
5.0-7.0 N·m

7

Wiring connection diagrams for PE cable

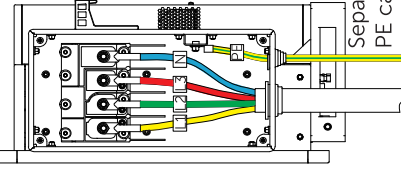

40 kW-70 kW / 75 kW-125 kW inverter

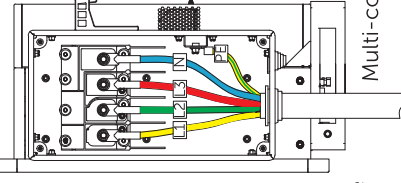

136 kW-150 kW inverter

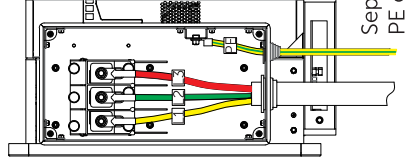

40 kW-70 kW / 75 kW-125 kW inverter

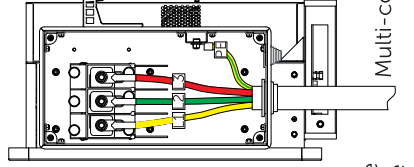

136 kW-150 kW inverter

DC Side Connection / Gleichstrom-seitiger Anschluss / Connexion côté CC / Conexión lateral de CC / Ligação lateral CC / Aansluiting gelijkspanningszijde / Collegamento lato CC / Połączenie po stronie DC / Боčni припоjení stejnosměrného proudu / Anslutning på DC-sidan / Conexiune laterală c.c. / Свързване от DC страната / DC-сидетилсутning / Πλαϊνή σύνδεση DC / Alalisvoolpoolne ühendus / DC-puolen liitäntä / Prikjučak za istosmjernu struju (DC) / Egyenáram-oldali bekötés / DC (nuol. sr.) šoninis kontaktas / Līdzstrāvas puses savienojums / Pripojenie na strane jednosmerného prúdu / DC stranska povezava / DC Yan Bağlantı / Conexão do Lado CC

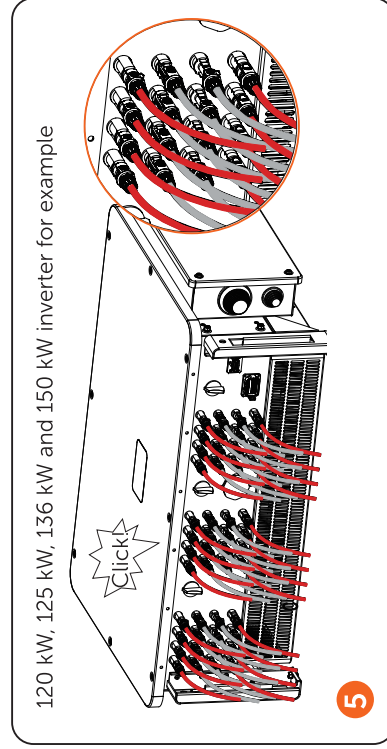
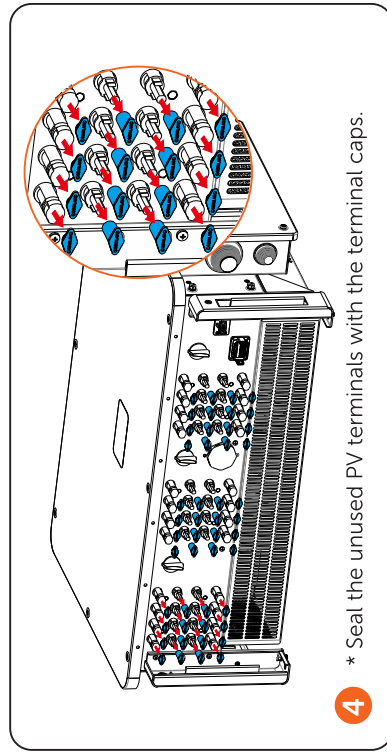
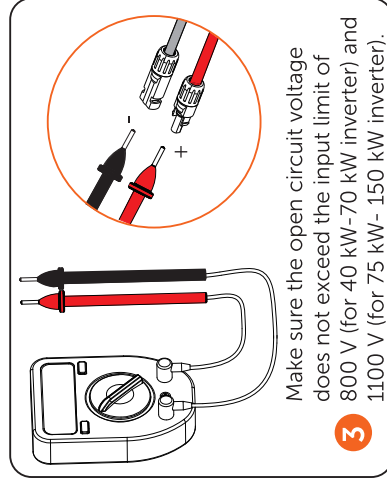
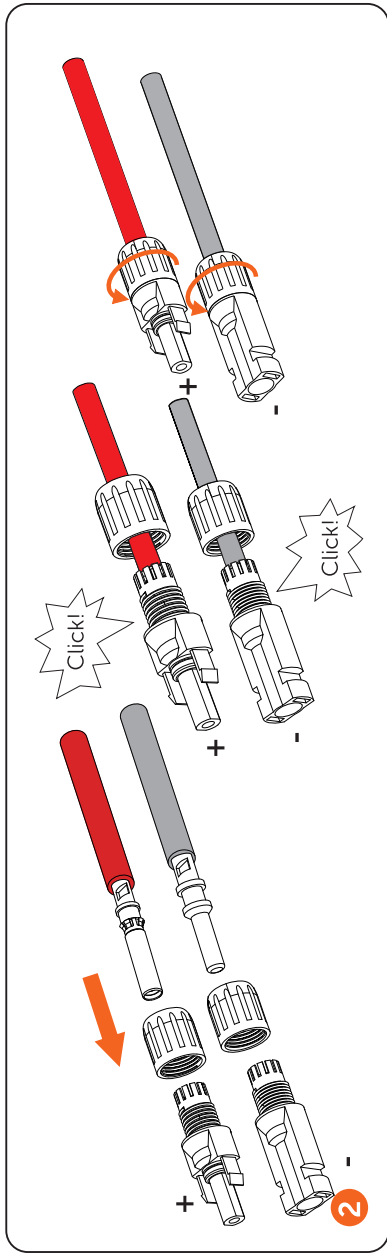
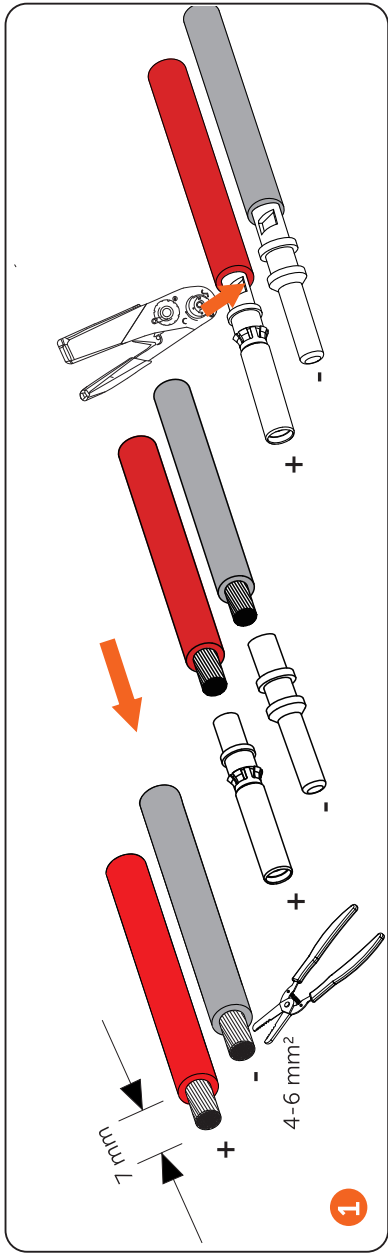

Communication Connection / Kommunikations-Anschluss / Branchement de communication / Conexión de comunicación / Ligaçãõ à Comunicação / Communicatie-aansluiting / Collegamento comunicazione / Potázenie komunikacyjne / Komunikáční pøípojení / Kommunikationsanslutning / Conexiune de comunicare / Κοινωνίασ / Коммуникационная вðьзка / Kommunikationsforbindelse / Σύνδεση / Κοινωνίασ bekõtés / Duomenų ryšys / Sakaru savienojums / Pripojenie komunikácie / Komunikacijska povezava / İletişim Bağlantısı / Conexão de Comunicação

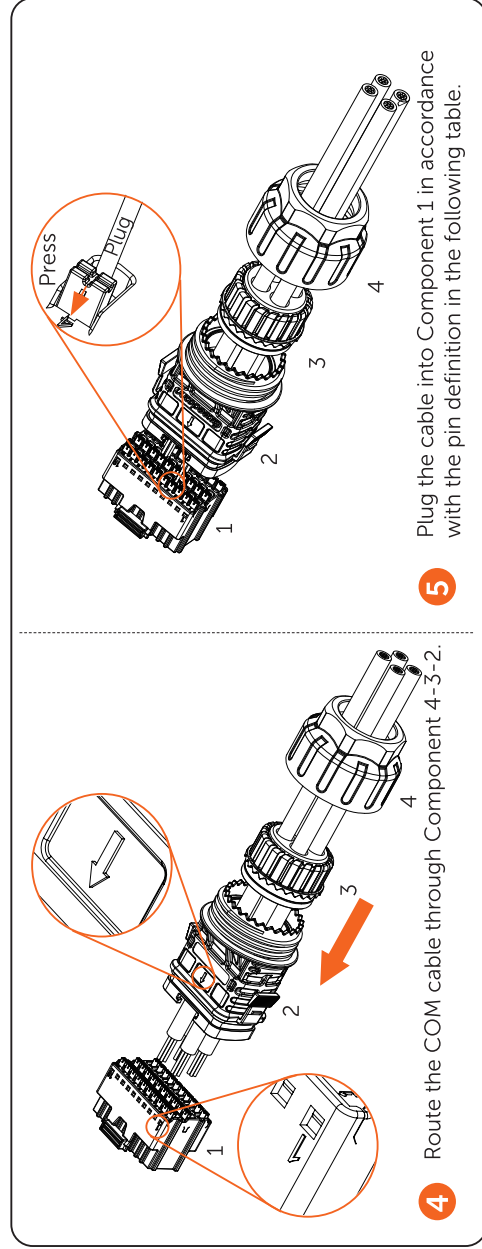
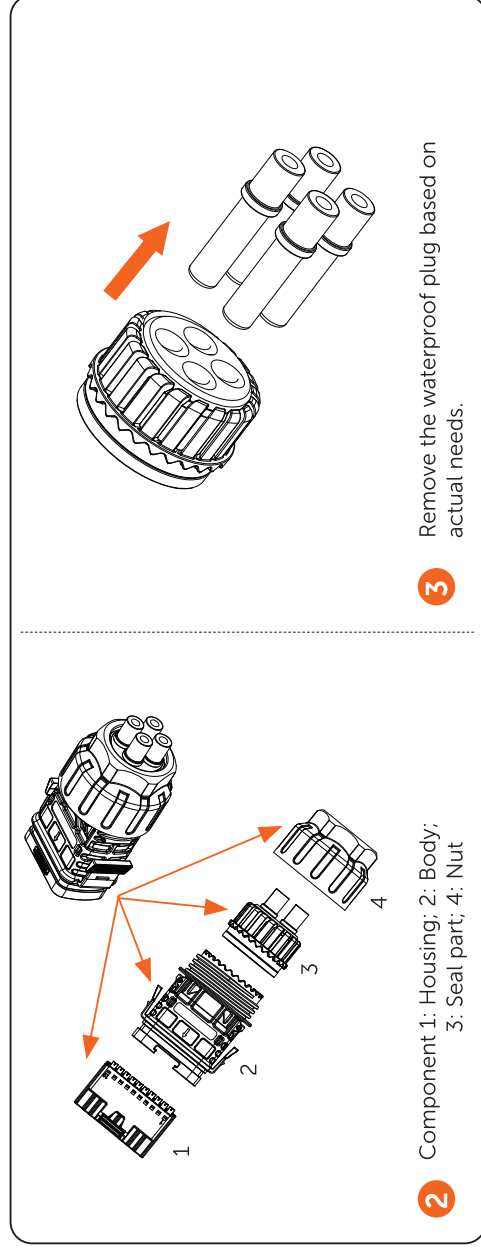
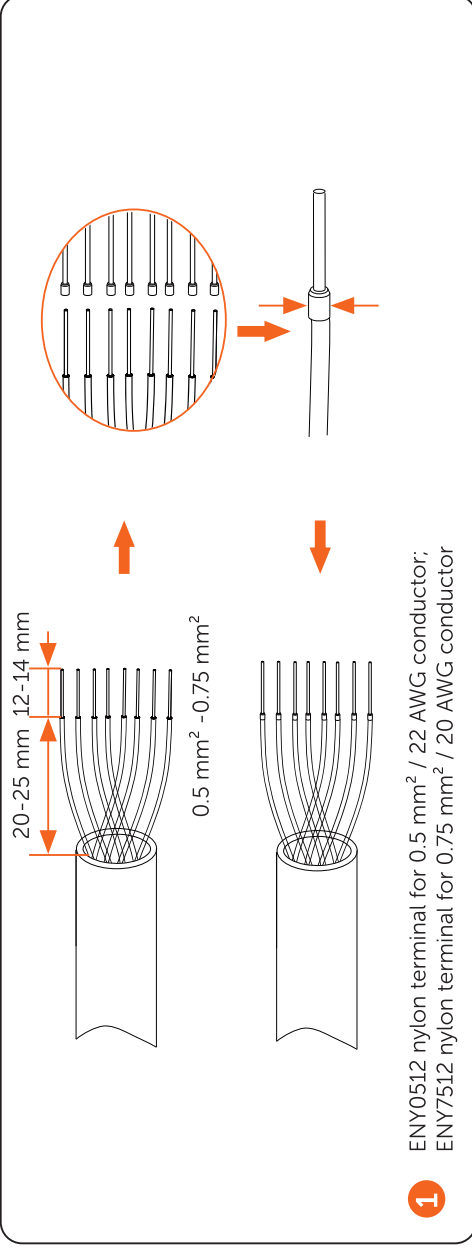

- Pin definition

| Function | Pin | Definition | Remark | |
|----------|-----|---------------|--|-----------------------|
| RS485-1 | 1 | RS485A IN+ | For inverter RS485 networking or connecting the data collector | |
| | 2 | RS485B IN- | | |
| | 3 | RS485 IN-GND | | |
| | 4 | RS485 OUT+ | | |
| | 5 | RS485 OUT- | | |
| | 6 | RS485 OUT-GND | | |
| RS485-2 | 7 | RS485A METER | For connecting RS485 meter or other devices | |
| | 8 | RS485B METER | | |
| | 9 | V+5V | | |
| | 10 | COM_GND | | |
| DRM | 11 | DRM1/5 | Reserved for DRM | |
| | 12 | DRM2/6 | | |
| | 13 | DRM3/7 | | |
| | 14 | DRM4/8 | | |
| | 15 | RG/0 | | |
| | 16 | CL/0 | | |
| | 21 | Digital IN+ | | Input digital signal |
| | 22 | Digital IN- | | Output digital signal |
| DI | 29 | Digital OUT+ | Output digital signal | |
| | 30 | Digital OUT- | | |

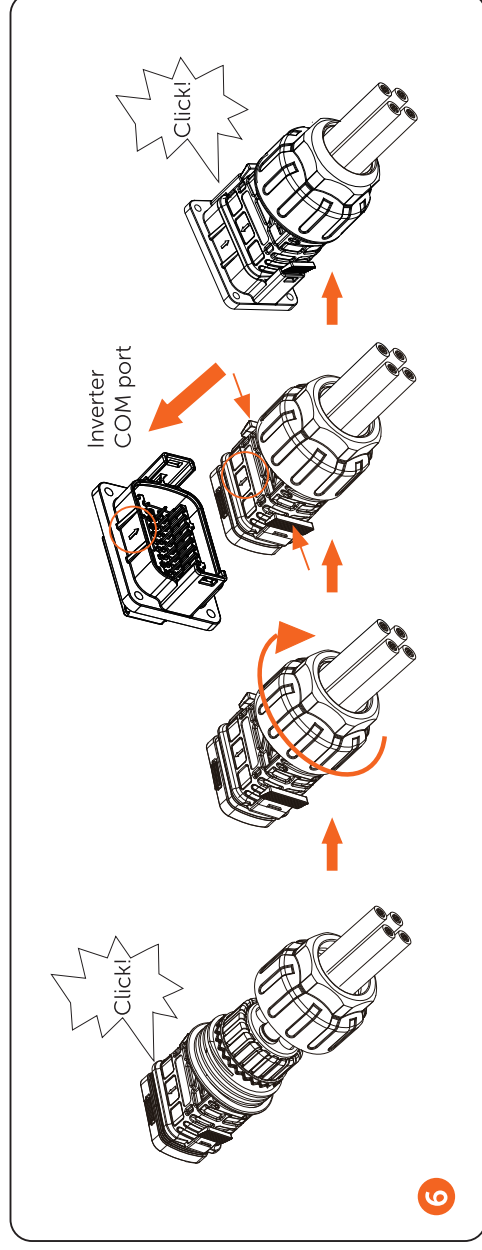

Monitoring Connection / Überwachungs-Anschluss / Branchement de surveillance / Conexión de monitorización / Ligaçã o Monitorizaçã o / Monitoring-aansluiting / Collegamento monitoraggio / Potaçzenie na potrzeby monitorowania / Připojení ke sledování / Övervakningsanslutning / Conexiune de monitorizare / Мониторингова връзка / Overvågningsforbindelse / Σύνδεση παρακολούθησης / Seire ühendus / Valvontaliitäntä / Prikliučak za nadzor / Monitoring bekötés / Stebėjimo ryšys / Uzraudzības savienojums / Pripojenie monitorovania / Povezava za spremljanje / izleme Bağlantısı / Conexão de Monitoramento

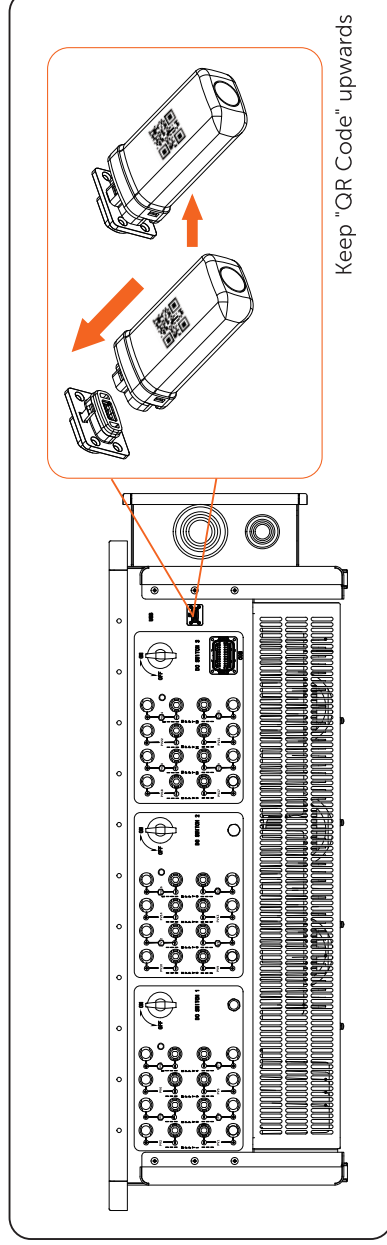

Power on the System / Schalten Sie das System ein / Mise sous tension du système / Encienda el sistema / Ligue o sistema / Het systeem inschakelen / Accensione del sistema / Właczanie systemu / Zapnutí systému / Slå på systemet / Pornire sistem / Включване на системата / Tænd for systemet / Ρεύμα στο σύστημα / Süsteemi sisselülitamine / Kytke järjestelmän virta päälle / Napájanje sustava / Rendszer áram alá helyezésé / Ijungti sistemą / Ieslēdziet sistēmu / Zapnite sistem / Vklõpite sistem / Sistemini Gücü / Ligar o Sistema

- Check before power-on
 - 1) The device is installed correctly and securely;
 - 2) All the DC breakers and AC breakers are OFF;
 - 3) All AC cables are connected correctly and securely;
 - 4) All DC cables are connected correctly and securely;
 - 5) All communication cables are connected correctly and securely;
 - 6) All the connectors which are not used should be sealed by covers.
 - 7) Make sure the PV module output is well insulated to ground;
 - 8) Make sure all PV modules should be of the same type, same model, same number, aligned and tilted identically;
 - 9) Make sure the open circuit voltage of the PV string shall not exceed 800 V (for 40 kW-70 kW inverter) and 1100 V (for 75 kW- 150 kW inverter) at the coldest expected temperature in time.
- Power on the system

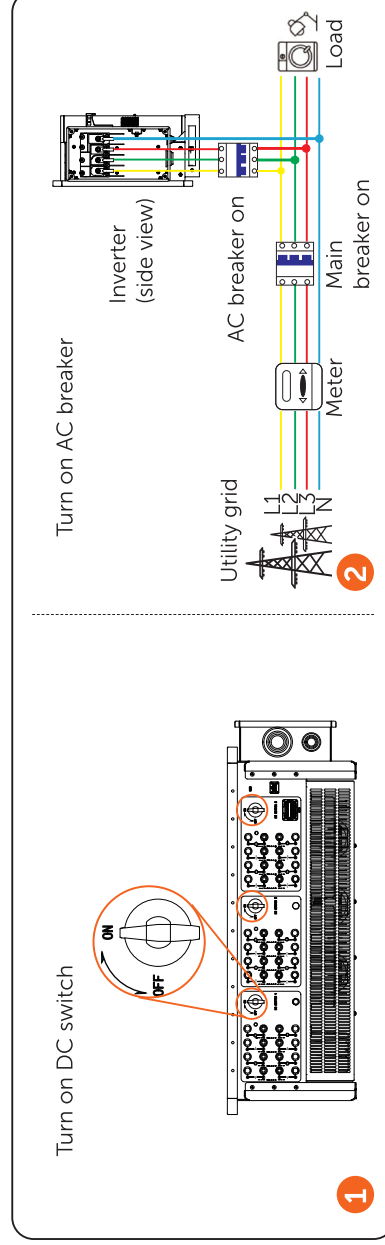

LCD Panel / LCD-Bildschirm / Panneau LCD / Panel LCD / Painel de LCD / LCD-paneel / Pannelo LCD / Panel LCD / LCD panel / LCD-panel / Панел / LCD панель / LCD-panel / Πάνελ LCD / LCD-paneel / LCD-paneeli / LCD ploča / LCD panel / LCD skydas / LCD panelis / LCD Panel / LCD plošča / LCD Panel / Painel LCD

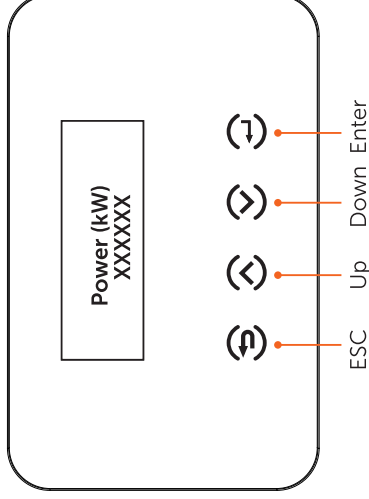



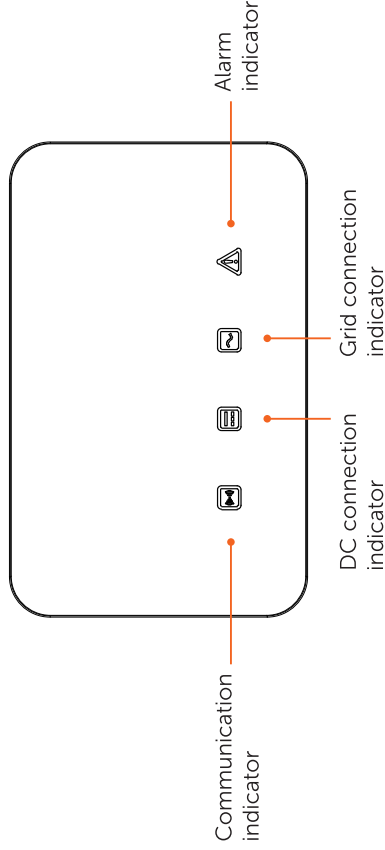

- In normal state, the "Power", "TodayEnergy", "TotalEnergy" and "Status" information will be displayed. You can press the keys to switch information.
- In error state, the fault message and error code will be displayed, please refer to the corresponding solutions in the user manual.

| Key | Definition |
|-----------|--|
| ESC key | Exit from the current interface or cancel the setting |
| Up key | Move the cursor to the previous option or increase the value |
| Down key | Move the cursor to the next option or decrease the value |
| Enter key | Enter the selected option or confirm the selection |

LED Indicators / LED-Indikatoren / Indicateurs LED / Indicadores LED / Indicadores LED / LED-indicatoren / Indicatori LED / Wskaźniki LED / LED indikatory / LED-indikatorer / Indicatori LED / LED индикатори / LED-indikatorer / Ενδεικτικές λυχνίες LED / LED-indikaatorid / LED-merkkivalot / LED pokazatelji / LED kijelzők / LED indikatoriai / LED indikatori / LED indikatory / LED kazalniki



| LED | Status | Definition |
|--|--------|--|
| Communication indicator (Blue)  | On | The inverter communication is normal. |
| | Flash | No communication data is sent or received for a long time. |
| DC connection indicator (Green)  | On | The inverter is in grid-connected state. |
| | Flash | Alarm indicator on: Errors occur on the inverter DC side. Alarm indicator off: No errors occur on the inverter DC side and at least one channel of MPPT input voltage is higher than 200 V. |
| Grid connection indicator (Green)  | Off | The input voltage of all channels of MPPT is less than 200 V; Or DC switch is not turned on. |
| | On | The inverter is in grid-connected state. |
| Alarm indicator (Red)  | Flash | Alarm indicator on: Errors occur on the inverter AC side. Alarm indicator off: AC grid is connected and the inverter is not in grid-connected state. |
| | Off | The inverter is not connected to the grid. |
| Alarm indicator (Red)  | On | Errors occur on the inverter. |
| | Off | No errors occur on the inverter. |

*** Note:**

In aging mode, alarm indicator is flashing and other indicators keep the current state;
In software upgrading state, all the indicators are blinking by horse-racing LED in circle;
When the software upgrading fails, the alarm indicator turns on and other three indicators will be off;
After the inverter upgrade succeeded, all the indicators will be off.

General Setting / Allgemeine Einstellungen / Paramètres généraux / Configuración general / Definição Geral / Algemeine instelling / Impostazione generale / Ustawienia ogólne / Obecné nastavení / Generell inställning / Setare general / Обща настройка / General indstilling / Γενική τοποθέτηση / Üldine seadistus / Yleisasetus / Opće postavke / Általános beállítás / Bendrasis nustatymas / Vispārīgs iestatījums / Všeobecné nastavenie / Splošna nastavitve / Genel Ayar / Configuração Geral

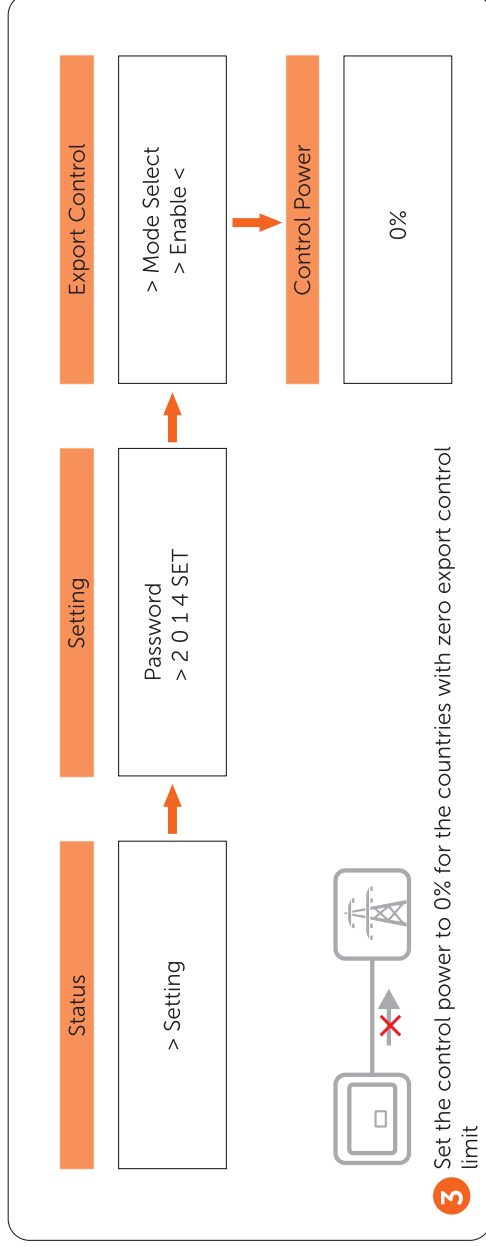
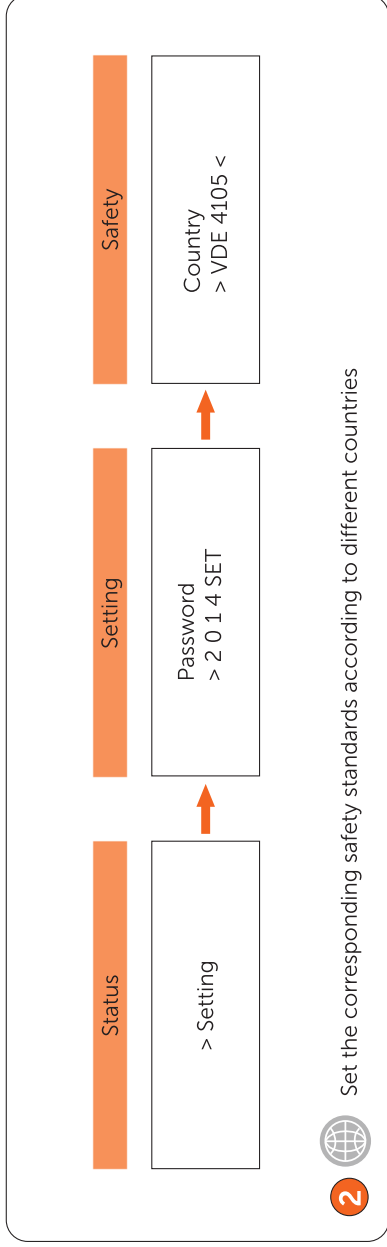
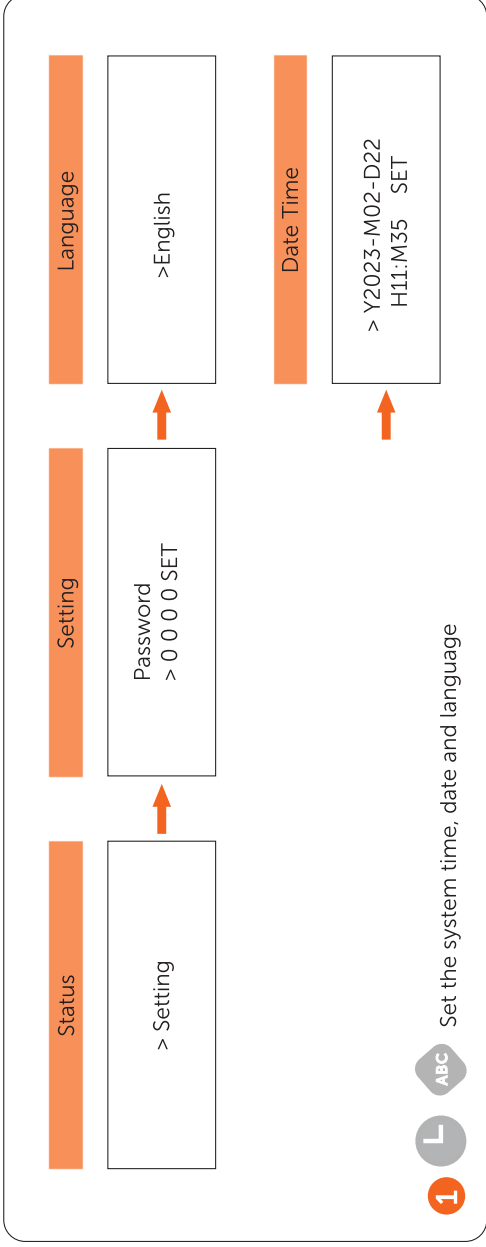

* Note: The initial password is 2014 which should be changed for the consideration of account security.

Wi-Fi Configuration / WLAN-Konfiguration / Configuration Wi-Fi / Configuración de wifi / Configuração de Wi-Fi/Wi-Fi-configuratie / Configurazione del Wi-Fi / Konfiguracja Wi-Fi / Konfigurace Wi-Fi / Wi-Fi-konfiguration / Configurare Wi-Fi / Wi-Fi конфигурация / WiFi-konfiguration / Ρυθμίσεις παραμέτρων Wi-Fi / Wi-Fi konfiguratsioon / Wi-Fi-kokoonpano / Konfiguracija Wi-Fi mreže / Wi-Fi konfiguráció / „Wi-Fi” konfiguracija / Wi-Fi konfigurácia / Konfiguracja Wi-Fi / Konfiguracija Wi-Fi / Wi-Fi Yapılandırması / Configuração Wi-Fi



1 Scan the QR code to download SolaXCloud App.

App Store

Google play

SolaXCloud

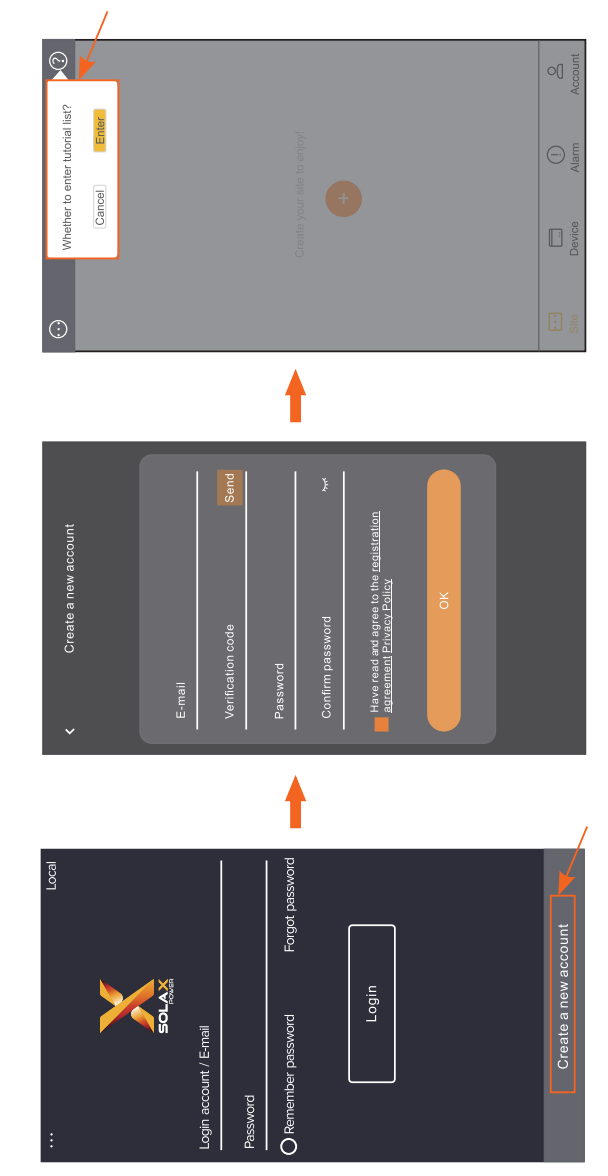

2 Create a new account and follow the tutorial on the SolaXCloud APP or the App guide at <https://www.solaxcloud.com/> to set the WiFi configuration.



Or scan the QR code to watch the WiFi configuration video on YouTube.

* **Note:** Configure the inverter parameters such as Date, Time, Safety, Export Control, ect. by SolaXCloud App.

Technical Data / Technische Daten / Fiche technique / Datos técnicos / Dados
 Técnico / Technische gegevens / Dati tecnici / Dane techniczne / Technické údaje /
 Tekniska data / Date tehnice / Технически данни / Tekniske data / Τεχνικά δεδομένα
 / Tehnilised andmed / Tekniset tiedot / Tehnički podaci / Műszaki adatok / Techniniai
 duomenys / Tehniskie dati / Technické údaje / Tehnični podatki / Teknik Bilgiler /
 Dados Técnicos

- DC input of 40 kW-70 kW inverter

| Model | X3-FTH-40K-LV | X3-FTH-50K-LV | X3-FTH-60K-LV | X3-FTH-70K-LV |
|---|---------------|---------------|---------------|---------------|
| Max. PV array input power [kWp] | 60 | 75 | 90 | 105 |
| Max. PV input voltage [V] | 800 | 800 | 800 | 800 |
| Nominal input voltage [V] | 360 | 360 | 360 | 360 |
| Startup voltage [V] | 200 | 200 | 200 | 200 |
| MPP tracker voltage range [V] | 180-650 | 180-650 | 180-650 | 180-650 |
| No. of MPP trackers | 6 | 6 | 9 | 9 |
| Strings per MPP tracker | 2 | 2 | 2 | 2 |
| Max. PV input current per MPPT [A] | 32 | 32 | 32 | 32 |
| Max. short circuit current per MPPT [A] | 46 | 46 | 46 | 46 |

- AC output of 40 kW-70 kW inverter

| Model | X3-FTH-40K-LV | X3-FTH-50K-LV | X3-FTH-60K-LV | X3-FTH-70K-LV |
|--|---------------------------|---------------|---------------|---------------|
| Nominal AC output power [kW] | 40 | 50 | 60 | 70 |
| Nominal AC output current [A] | 105 | 131.3 | 157.5 | 183.7 |
| Max. AC output apparent power [kVA] | 44 | 55 | 66 | 70 |
| Max. AC output current [A] | 115.5 | 144.5 | 173.5 | 183.7 |
| Current (inrush) [A] | 115.5 | 144.5 | 173.5 | 183.7 |
| Nominal AC voltage [V] | 127/220, 3W/(N)/PE | | | |
| Nominal AC frequency/AC frequency range [Hz]** | 50/60; ±5 | | | |
| Displacement power factor | 0.8 leading - 0.8 lagging | | | |
| THDi (Rated power) [%] | <3% | | | |
| Max. output fault current [A] | 370 | | | |
| Max. output overcurrent protection [A] | 370 | | | |

- System data of 40 kW-70 kW inverter

| Model | X3-FTH-40K-LV | X3-FTH-50K-LV | X3-FTH-60K-LV | X3-FTH-70K-LV |
|----------------------------------|--|---------------|---------------|---------------|
| Max. efficiency [%] | 98.0 | | | |
| Protection level | IP66 | | | |
| Operating temperature range [°C] | -25 to +60 | | | |
| Max. operation altitude [m] | 4000 | | | |
| Relative humidity [%] | 0-100 | | | |
| Dimensions (W x H x D) [mm] | 985 x 660 x 327.5 | | | |
| Weight [kg] | 80.5 kg | | | 83 kg |
| Cooling concept | Smart fan cooling | | | |
| Communication interfaces | RS485 / (Optional: Pocket Wifi/LAN/4G) / PLC(Optional) / USB | | | |

- Protection of 40 kW-70 kW inverter

| Model | X3-FTH-40K-LV | X3-FTH-50K-LV | X3-FTH-60K-LV | X3-FTH-70K-LV |
|-------------------------------|-----------------|---------------|---------------|---------------|
| DC Switch | Yes | | | |
| Over/under voltage protection | Yes | | | |
| DC isolation protection | Yes | | | |
| Grid monitoring | Yes | | | |
| DC injection monitoring | Yes | | | |
| Residual current detection | Yes | | | |
| Anti-Islanding protection | Yes | | | |
| String fault detection | Yes | | | |
| SPD (DC/AC) | Type II/Type II | | | |

- Standard of 40 kW-70 kW inverter

| Model | X3-FTH-40K-LV | X3-FTH-50K-LV | X3-FTH-60K-LV | X3-FTH-70K-LV |
|-----------------|--|---------------|---------------|---------------|
| Safety Standard | IEC/EN 62109-1; IEC/EN 62109-2; NB/T 32004 | | | |
| EMC | IEC/EN 61000; NB/T 32004 | | | |
| Certification | NB/T 32004; IEC 61727; IEC62116; VDE4110; VDE4105; En50549; NRS097; G99; Rdl699; PPDS2022; CEI0-21; CEI0-16;VFR 2019 | | | |

* **Note:** The AC voltage and the frequency range may be different according to different country codes.

** **Note:** The AC voltage and the frequency range may vary from different country codes.

• DC input of 75 kW-150 kW inverter

| Model | X3-FTH-75K | X3-FTH-80K | X3-FTH-100K | X3-FTH-110K | X3-FTH-120K | X3-FTH-125K | X3-FTH-136K-MV | X3-FTH-150K-MV |
|---|------------|------------|-------------|-------------|-------------|-------------|----------------|----------------|
| Max. PV array input power [kWp] | 120 | 120 | 150 | 165 | 180 | 188 | 204 | 225 |
| Max. PV input voltage [V] | 1100 | 1100 | 1100 | 1100 | 1100 | 1100 | 1100 | 1100 |
| Nominal input voltage [V]* | 580/600 | 580/600 | 580/600 | 580/600 | 580/600 | 580/600 | 730/785 | 730/785 |
| Startup voltage [V] | 200 | 200 | 200 | 200 | 200 | 200 | 200 | 200 |
| MPP tracker voltage range [V] | 180-1000 | 180-1000 | 180-1000 | 180-1000 | 180-1000 | 180-1000 | 180-1000 | 180-1000 |
| No. of MPP trackers | 9 | 9 | 9/12 | 9/12 | 12 | 12 | 12 | 12 |
| Strings per MPP tracker | 2 | 2 | 2 | 2 | 2 | 2 | 2 | 2 |
| Max. PV input current per MPPT [A] | 32 | 32 | 32 | 32 | 32 | 32 | 32 | 32 |
| Isc PV Array Short Circuit current per MPPT [A] | 46 | 46 | 46 | 46 | 46 | 46 | 46 | 46 |

• AC output of 75 kW-150 kW inverter

| Model | X3-FTH-75K | X3-FTH-80K | X3-FTH-100K | X3-FTH-110K | X3-FTH-120K | X3-FTH-125K | X3-FTH-136K-MV | X3-FTH-150K-MV |
|--|-----------------------------|--------------|--------------|--------------|-------------|--------------|----------------|----------------|
| Rated AC output power [kW] | 75 | 80 | 100 | 110 | 120 | 125 | 136 | 150 |
| Rated AC output current [A]* | 113.7 /108.7 | 121.3 /116 | 151.6 /145 | 166.7 /159.5 | 181.9 /174 | 189.4 /181.2 | 157.1 /145.4 | 173.2 /160.4 |
| Max. AC output apparent power [kVA] | 75 | 88 | 110 | 121 | 132 | 132 | 149.6 | 165 |
| Max. AC output current [A]* | 113.7 /108.7 | 133.4 /127.6 | 166.7 /159.5 | 183.4 /175.4 | 200 /191.3 | 200 /191.3 | 172.8 /160 | 190.6 /176.5 |
| Current (inrush) [A]* | 113.7 /108.7 | 133.4 /127.6 | 166.7 /159.5 | 183.4 /175.4 | 200 /191.3 | 200 /191.3 | 172.8 /160 | 190.6 /176.5 |
| Nominal AC voltage [V] | 220/380, 230/400, 3W/(N)/PE | | | | | | | |
| AC voltage range [V]** | 176 - 276/304 - 480 | | | | | | | |
| Nominal AC frequency/AC frequency range [Hz]** | 50/60; ±5 | | | | | | | |
| THDi (Rated power) [%] | <3 | | | | | | | |
| Power Factor range | 0.8 leading - 0.8 lagging | | | | | | | |
| Max. output fault current [A] | 370 | | | | | | | |
| Max. output overcurrent protection [A] | 370 | | | | | | | |

• System data of 75 kW-150 kW inverter

| Model | X3-FTH-75K | X3-FTH-80K | X3-FTH-100K | X3-FTH-110K | X3-FTH-120K | X3-FTH-125K | X3-FTH-136K-MV | X3-FTH-150K-MV |
|---------------------|------------|------------|-------------|-------------|-------------|-------------|----------------|----------------|
| Max. efficiency [%] | 98.6 | 98.6 | 98.6 | 98.6 | 98.6 | 98.6 | 99.0 | 99.0 |
| Ingress protection | IP66 | | | | | | | |

| | | |
|--|-----------------------------------|----|
| Operating ambient temperature range [°C] | -25 to +60 (Derating above 45) | |
| Max. operation altitude [m] | 4000 (Derating above 3000) | |
| Relative humidity [%] | 0-100 | |
| Dimensions (W x H x D) [mm] | 985 x 660 x 327.5 | |
| Weight [kg] | 83 | 87 |
| Cooling concept | Smart fan cooling | |
| Communication interfaces | RS485 / USB / DRM / PLC(Optional) | |
| Optional monitoring dongle | Pocket WiFi/LAN/4G | |
| Display | LED indicator x 4; LCD(Optional) | |

- Protection of 75 kW-150 kW inverter

| Model | X3-FTH-75K | X3-FTH-80K | X3-FTH-100K | X3-FTH-110K | X3-FTH-120K | X3-FTH-125K | X3-FTH-136K-MV | X3-FTH-150K-MV |
|---|-----------------|------------|-------------|-------------|-------------|-------------|----------------|----------------|
| Over/under voltage protection | Yes | | | | | | | |
| IDC isolation protection | Yes | | | | | | | |
| Grid monitoring | Yes | | | | | | | |
| DC injection monitoring | Yes | | | | | | | |
| Residual current detection | Yes | | | | | | | |
| Anti-islanding protection | Yes | | | | | | | |
| String fault detection | Yes | | | | | | | |
| SPD (DC/AC) | Type II/Type II | | | | | | | |
| Arc-fault circuit interrupter(AFCI) | Optional | | | | | | | |
| AC terminals over temperature detection | Yes | | | | | | | |
| AC auxiliary power supply(APS) | Optional | | | | | | | |
| Power line communication(PLC) | Optional | | | | | | | |

- Standard of 75 kW-150 kW inverter

| Model | X3-FTH-75K | X3-FTH-80K | X3-FTH-100K | X3-FTH-110K | X3-FTH-120K | X3-FTH-125K | X3-FTH-136K-MV | X3-FTH-150K-MV |
|---------------|--|------------|-------------|-------------|-------------|-------------|----------------|----------------|
| Safety | IEC/EN 62109-1; IEC/EN 62109-2; NB/T 32004 | | | | | | | |
| EMC | IEC/EN 61000; NB/T 32004 | | | | | | | |
| Certification | NB/T 32004; IEC 61727; IEC 62116; VDE4110; VDE4105; EN50549; NRS097; G99; RD1699; PPDS2022; CEIO-21; CEIO-16; VFR 2019 | | | | | | | |



* **Note:** The two data refer to different grid voltage 220V/230V or 500V/540V.

** **Note:** The AC voltage and the frequency range may vary from different country codes.

Contact Information





UNITED KINGDOM

 Unit 10, Eastboro Fields, Hemdale Business Park, Nuneaton, CV11 6GL
 +44 (0) 2476 586 998
 service.uk@solaxpower.com





AUSTRALIA

 12-18 Lascelles St, Springvale VIC 3171
 +61 1300 476 529
 service@solaxpower.com





TURKEY

 Esenşehir Mah. Hale Sk. No:6/1 Ümraniye / İSTANBUL
 +90 (216) 622 58 00 (pbx)
 service.eu@solaxpower.com





GERMANY

 Eisenstraße 3, 65428 Rüsselsheim am Main, Germany
 +49 (0) 6142 4091 664
 service.eu@solaxpower.com







USA

 3780 Kilroy Airport Way, Suite 200, Long Beach, CA, US 90806
 +1 (408) 690 9464
 info@solaxpower.com



NETHERLANDS

 Twekkeler-Es 15 7547 ST Enschede
 +31 (0) 8527 37932
 service.eu@solaxpower.com
 service.bnl@solaxpower.com



POLAND

 WARSAW AL. JANA P. II 27. POST
 +48 662 430 292
 service.pl@solaxpower.com



SPAIN

 +34 9373 79607
 tecnico@solaxpower.com





ITALY

 +39 348 2786 409
 support.it@solaxpower.com



BRAZIL

 +55 (34) 9667 0319
 info@solaxpower.com

Warranty Registration Form



For Customer (Compulsory)

Name Country

Phone Number Email

Address

State Zip Code

Product Serial Number

Date of Commissioning

Installation Company Name

Installer Name Electrician License No.

For Installer

Module (If Any)

Module Brand

Module Size(W)

Number of String Number of Panel Per String

Battery (If Any)

Battery Type

Brand

Number of Battery Attached

Date of Delivery Signature

Please visit our warranty website: <https://www.solaxcloud.com/#/warranty> or use your mobile phone to scan the QR code to complete the online warranty registration.



For more detailed warranty terms, please visit SolaX official website: www.solaxpower.com to check it.





SolaX Power Network Technology (Zhejiang) Co., Ltd.

Add.: No. 288, Shizhu Road, Tonglu Economic Development Zone,
Tonglu City, Zhejiang Province, 310000 P. R. CHINA

Tel.: +86 (0) 571 5626 0011

E-mail: info@solaxpower.com / service@solaxpower.com



320102069402

Copyright © SolaX Power Technology (Zhejiang) Co., Ltd. All rights reserved.